

Smart panel

Model No.: TWZS1

Capacitive touch screen / Light sensor / Auto-sync / WiFi, Zigbee wireless protocol / Compatible with Tuya eco devices / 86 concealed box installation

Features

- Integrated Zigbee gateway function, the controller device can be used without an external zigbee gateway.
- Network connection via wireless WiFi.
- Automatically adjust the screen brightness according to surroundings.
- Compatible with most Graffiti eco devices.
- By scanning the code and binding the Smart Panel, the Smart Panel automatically synchronises the group and scene functions of the lights in the Tuya/Smart Life APP.
- Zero Firewire installation with standard 86 box.



CE RoHS

Technical Parameters

Hardware parameters	
Input voltage	100-240VAC
Screen	4inch/Resolution 480 x 480/Multi-touch
Store	1GB RAM/8GB ROM
Wireless protocol	WiFi, Zigbee
Warranty	5 years

Environment	
Working Temperature	Ta: 0°C~ 40°C
Working Humidity	5% to 90% RH(non-condensing)
Package	
Size	L110 xW110 x H75mm
Gross weight	0.223kg

Mechanical Structures and Installations

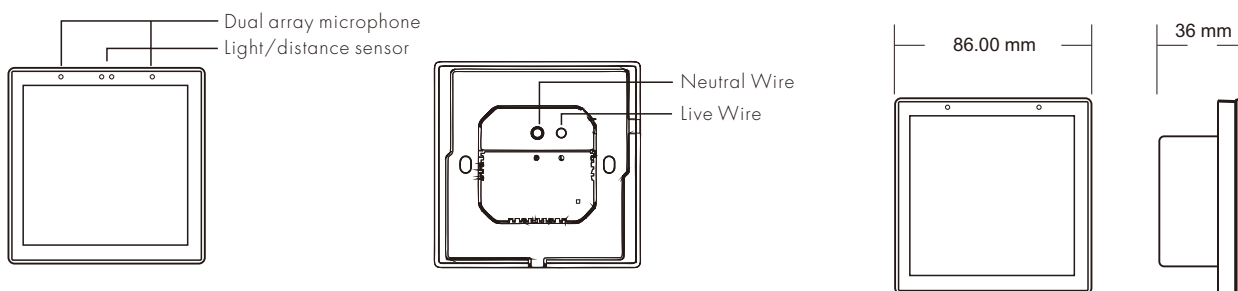

Installation drawings

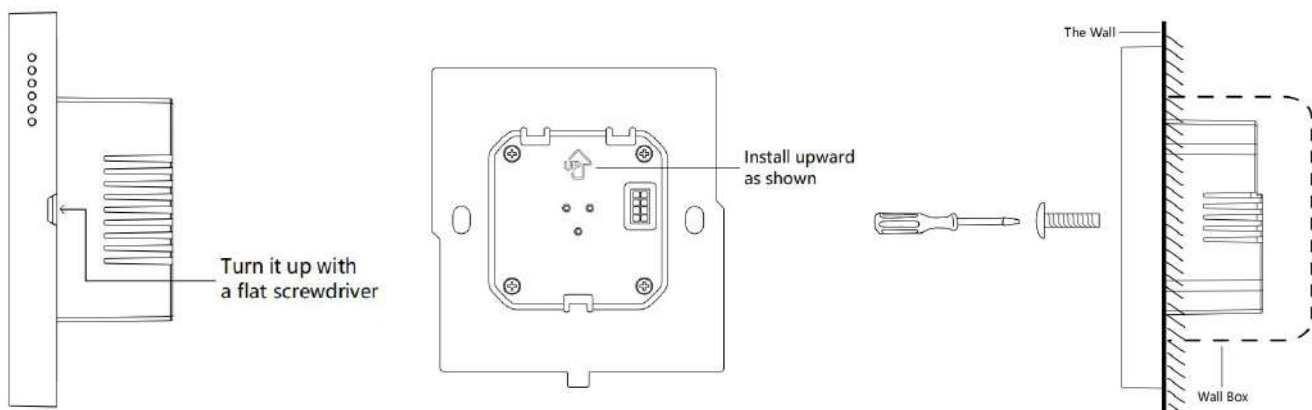

System wiring

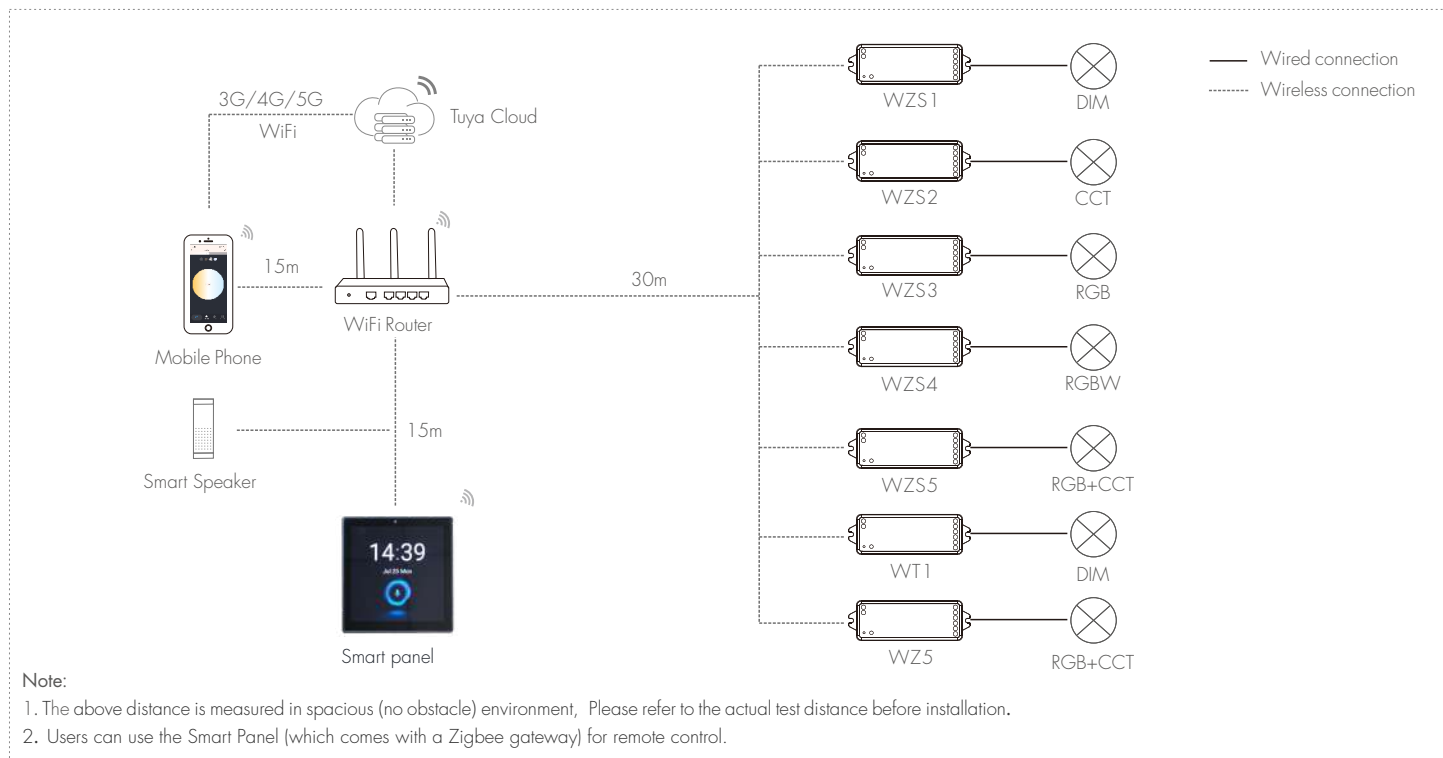

APP Operating Instructions

1. Distribution network and basic setup

Please download the corresponding tuya/smart life app according to your region.

When using the device for the first time, scan the QR code with the Tuya/Smart Life App to bind your account.

Swipe down at the top of the Smart Panel screen to bring up the settings screen, click on "Settings" and connect to wireless WiFi in the network settings.

In the Tuya/Smart Life App, click on "Smart Panel" >> "Gateway" >> "Add Sub-Device" to complete the addition of the device.



Smart life APP



Tuya Smart

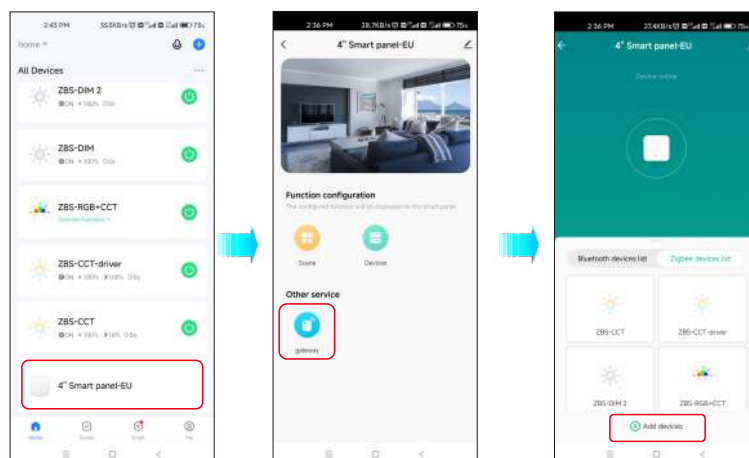
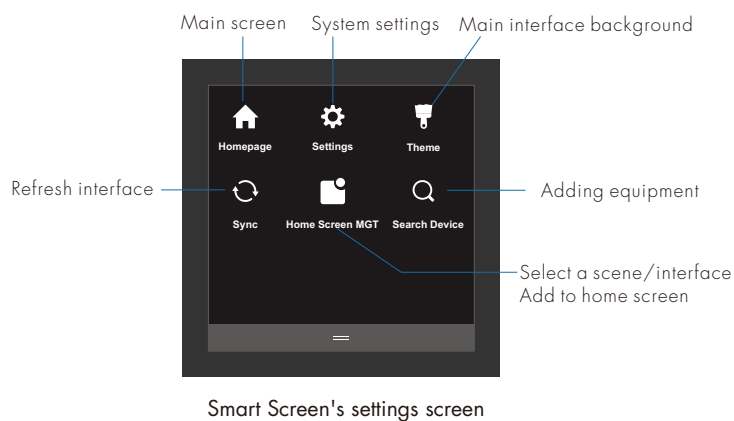

2. Introduction to basic functions

- (1) Main screen showing time, date, 2 devices or scenes.
- (2) The left screen scene interface is a scene mode composed by the device, which can be called up directly (the scene needs to be set up in the Tuya/Smart Life App for this function).
- (3) The right screen Smart Home interface is where all the devices are added and can be controlled individually.
- (4) Network setting: WLAN settings, Ethernet settings.
- (5) Voice Control and Volume: Set the volume level.
- (6) Display adjustment: Can be used for brightness adjustment, screensaver function.
- (7) Device and System: Displays the device name, model, system upgrade for rebooting the device, unbundling the device or restoring factory settings.
- (8) Date and time: Synchronous date and time switch, support manual setting date and time.
- (9) Homepage Theme: Toggle the wallpaper on the main screen.

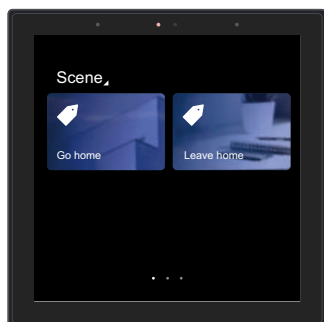

Left screen scene call screen

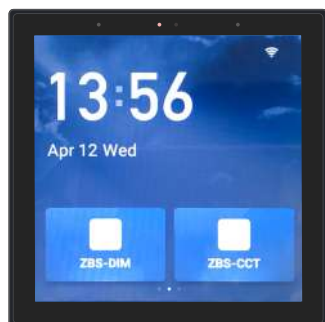

Main screen

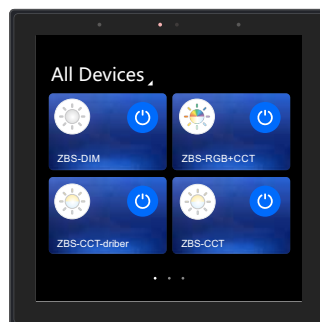

Right screen smart home device interface

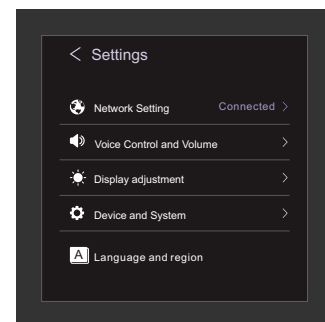

System setup screen

3. Scene creation (operated in the mobile app)

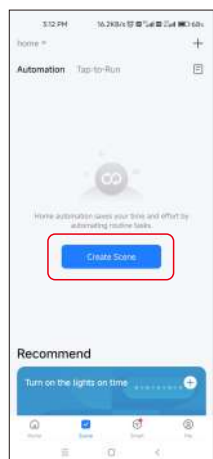

Click on "Scenes" >>
"Create a smart scene"
Click on "Scenes" >>
"Create a smart scene"

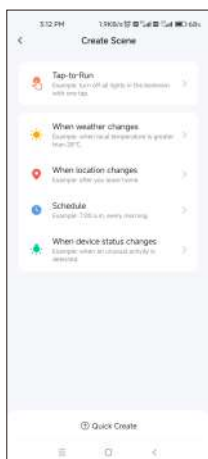

Click on the one-click
execution for scene setting

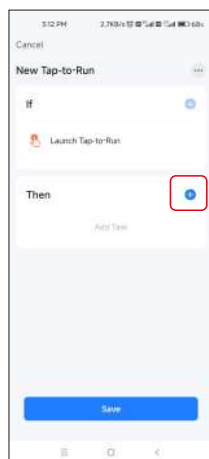

Go to the new one-click
execution screen.
Click on the plus sign to the
right of the execution bar.

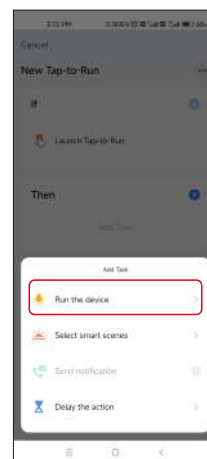

Click on "Operating Equipment"



Select the device to be
controlled, for example
"ZBS-CCT"

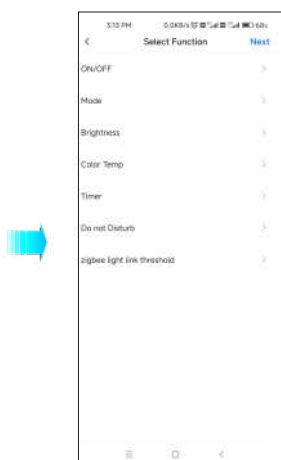

Select scene function

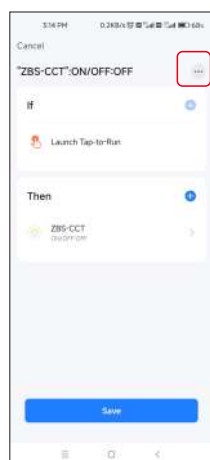

Once the function selection
is complete, edit the scene
name.

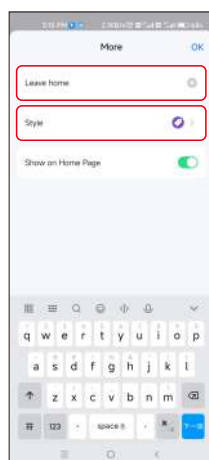

Edit the scene name and icon,
OK and save to complete the setup.

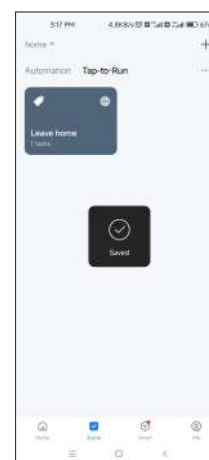

Scene creation complete

5. Dimming function

From the main screen, swipe left to the display device screen.

For different devices with different dimming types, click on the device to access its corresponding dimming function screen.

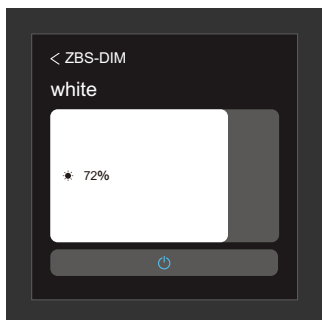

Single colour dimming:

Touch the brightness bar to adjust the brightness.

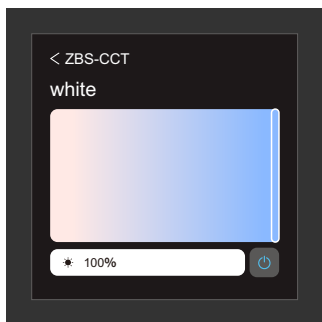

CCT dimming:

Touch the colour temperature bar to adjust the colour temperature.

Touch the brightness bar to adjust the brightness.

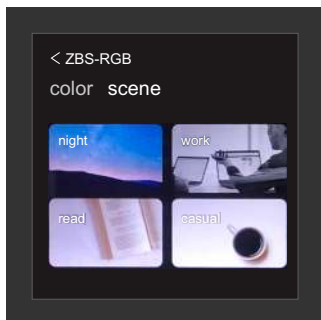
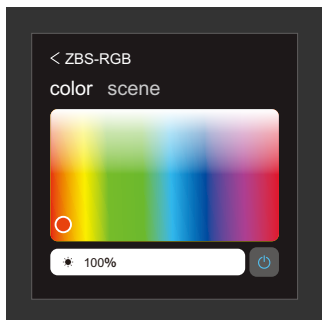

RGB dimming :

Colour light interface, touch the colour bar to change the static RGB colour.

Touch the brightness bar to adjust the RGB colour brightness.

Scene interface:

4 scenes can be tuned (night, read, work, casual).

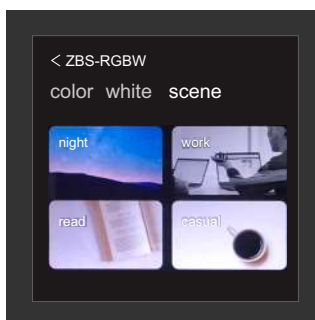
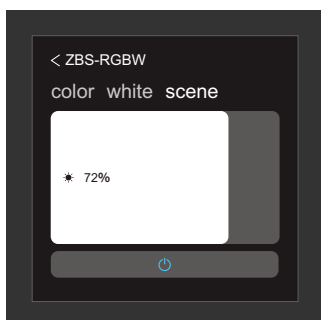
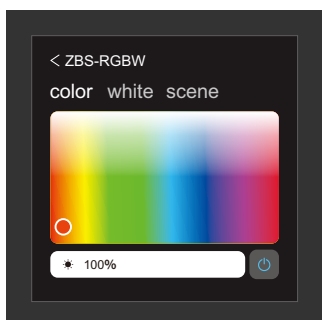

RGBW dimming:

Colour light interface, touch the colour bar to change the static RGB colour and touch the brightness bar to adjust the RGB colour brightness. White light interface, touch the brightness bar to adjust the W brightness.

Scene interface:

4 scenes can be tuned (night, read, work, casual).

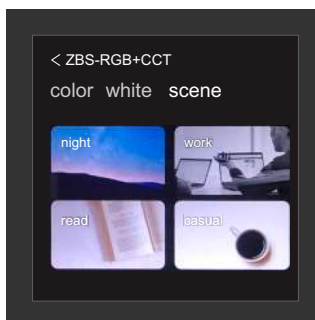
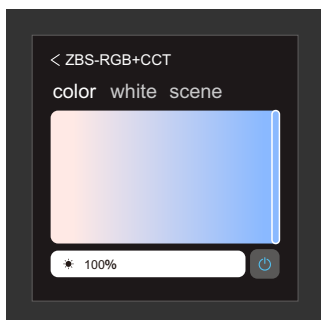
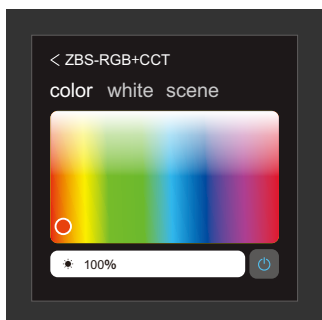

RGB+CCT dimming :

Color light interface, touch the color bar to change the static RGB color and touch the brightness bar to adjust the RGB color brightness. White light interface, touch the color temperature bar to adjust the color temperature, touch the brightness bar to adjust the color temperature brightness.

Scene interface:

4 scenes can be tuned (night, read, work, casual).

Note:

1. Smart panels must use networks under the 2.4GHz band.
2. Supports up to 50 sub-devices of Zigbee communication type into the network.