

LED PANEL ESSENCE



KEY FEATURES

- Slim design suitable for suspended and plaster ceilings
- Replacement of 4x18W FL and 2x36W
- Flicker-free
- Efficiency 100 lm/W
- Long lifetime 50,000 hours
- Included driver with fast-connector
- Complete accessories range
- Payback time 1 to 2 years
- 5 years Pragmalux warranty

APPLICATIONS



Office



Education



Healthcare



Retail

OPTIONS



300x1200 version



Junction box

SPECIFICATIONS

Item code	Description	W	lm	lm/W	Kelvin	CRI	Input current	Lifetime L80B10	Equivalent	Beam angle
4600239	LED Panel Essence 40W 600 3000K	40	4,000	100	3,000	≥80	0.20A	50,000	4x18W FL	120°
4600246	LED Panel Essence 40W 600 4000K	40	4,000	100	4,000	≥80	0.20A	50,000	4x18W FL	120°
4600253	LED Panel Essence 40W 620 3000K	40	4,000	100	3,000	≥80	0.20A	50,000	4x18W FL	120°
4600260	LED Panel Essence 40W 620 4000K	40	4,000	100	4,000	≥80	0.20A	50,000	4x18W FL	120°
4600277	LED Panel Essence 40W 1200 3000K	40	4,000	100	3,000	≥80	0.20A	50,000	2x36W FL	120°
4600284	LED Panel Essence 40W 1200 4000K	40	4,000	100	4,000	≥80	0.20A	50,000	2x36W FL	120°

TECHNICAL DATA

Electrical data	
Voltage (V)	220-240
Frequency (Hz)	50/60
Power factor (λ)	≥0.9
Operating mode	External LED Driver
Electrical connection	Max 2x2,5 mm ² wire
Total harmonic distortion	≤ 20 %

Certificates & standards	
Driver certificates	CE
Fixture certificates	CE
Ingress protection	IP20
Protection class	II
Protection class IK	02
Glow Wire Test (IEC 695-2-1)	650°C
Photobiological safety group EN62778	RG0

Temperatures & operating conditions

Ambient temperature	25°C
Operating temperature	-15 ~ +40°C
Storage temperature	-20 ~ +60°C

Colors & materials

Color (Housing)	White (RAL9003)
Material (Housing)	Aluminum
Material (Diffuser)	PS

Capabilities

UGR	≤22
Dimmable	No
Type of connection	Push Terminal, 2-pole
LED Module replacable	No
Installation	Through-wiring Possible

SPECIFICATIONS DRIVERS

Item code	Description	Output current	Driver failure rate at 5,000h	Inrush current Ipeak	Inrush current Twidth	Max. No. of drivers on MCB Type B 10A	Max. No. of drivers on MCB Type B 16A	Max No.of drivers on MCB Type C 10A	Max. No. of drivers on MCB Type C 16A
4600239	LED Panel Essence 40W 600 3000K	1.2A	≤1%	14.4A	460μs	10	17	18	30
4600246	LED Panel Essence 40W 600 4000K	1.2A	≤1%	14.4A	460μs	10	17	18	30
4600253	LED Panel Essence 40W 620 3000K	1.2A	≤1%	14.4A	460μs	10	17	18	30
4600260	LED Panel Essence 40W 620 4000K	1.2A	≤1%	14.4A	460μs	10	17	18	30
4600277	LED Panel Essence 40W 1200 3000K	1.2A	≤1%	14.4A	460μs	10	17	18	30
4600284	LED Panel Essence 40W 1200 4000K	1.2A	≤1%	14.4A	460μs	10	17	18	30

DIMENSIONS

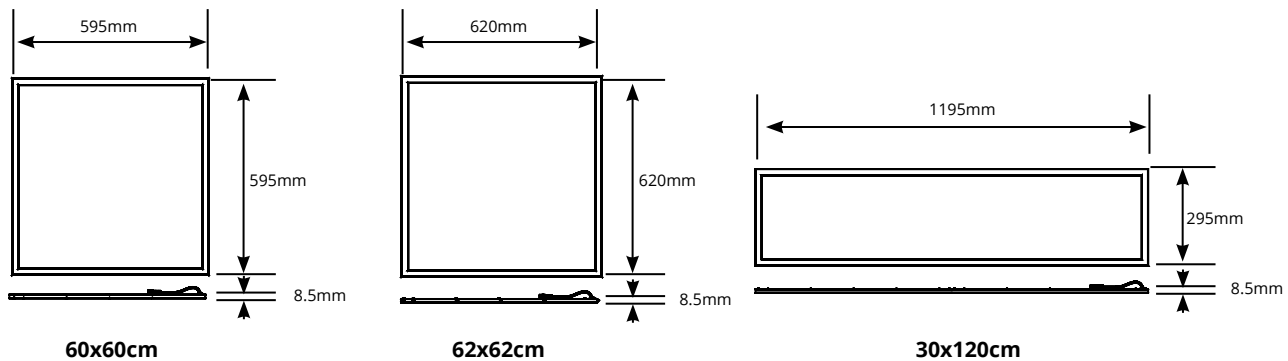

ACCESSORIES

Item code	Description
4600369	LED Panel Surface Mounted Kit 600
4600376	LED Panel Surface Mounted Kit 620
4600383	LED Panel Surface Mounted Kit 1200
4600406	LED Panel Surface Mounted Kit Quick 600
4600413	LED Panel Surface Mounted Kit Quick 620
4600420	LED Panel Surface Mounted Kit Quick 1200
4600437	LED Panel Suspension Kit
4600444	LED Panel Mounting Clips 600/620 (4pcs)
4600451	LED Panel Safety Cable 1M

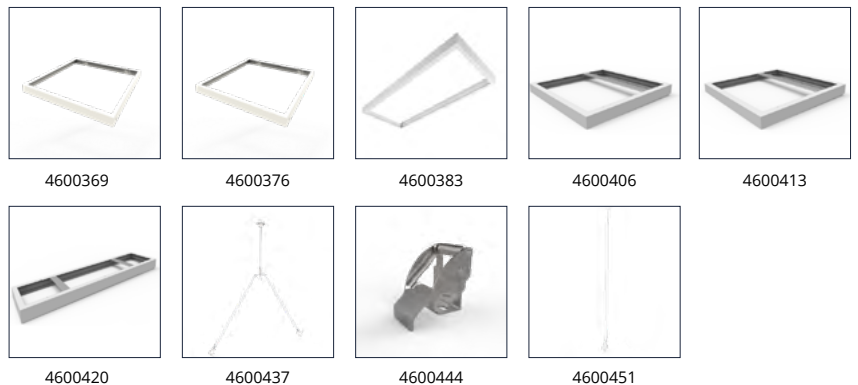

PRAGMALUX

All rights reserved. Pragmalux - PDL Lighting Group B.V. retains the right to modify product specifications without any prior notice or obligation and does not assume any liability for any consequences of using this document. Subject to errors and printing errors. Luminous flux tolerance: +/- 10%. Power consumption tolerance: +/- 10%.

Version: August 2019

PHOTOMETRIC SPECIFICATIONS

LED Panel Essence 40W 600 3000K

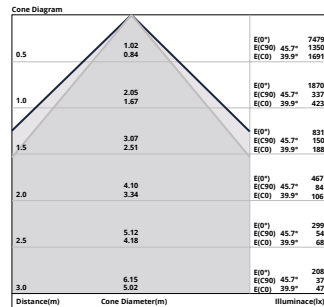
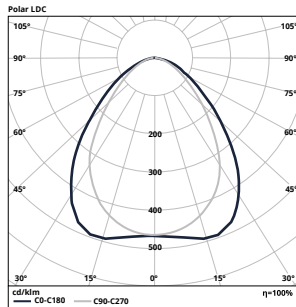

LED Panel Essence 40W 600 4000K

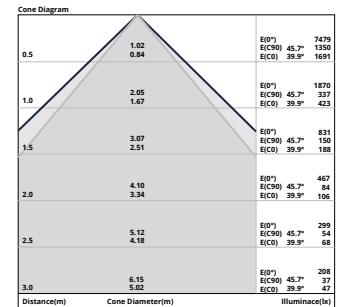
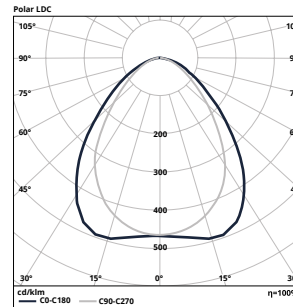

LED Panel Essence 40W 620 3000K

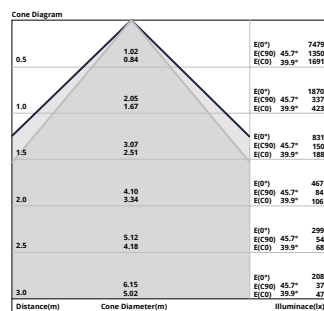
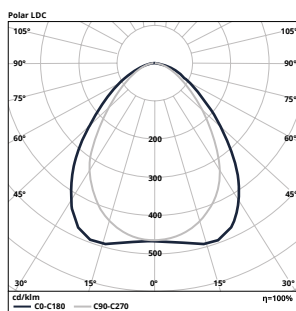

LED Panel Essence 40W 620 4000K

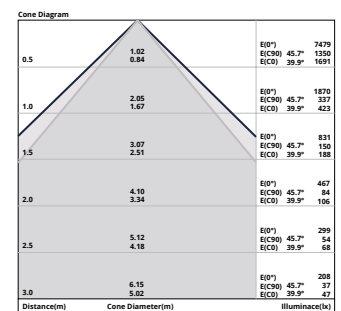
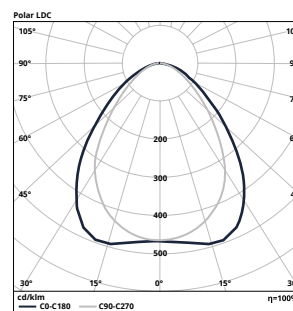

LED Panel Essence 40W 1200 3000K

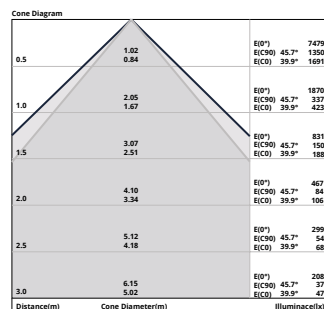
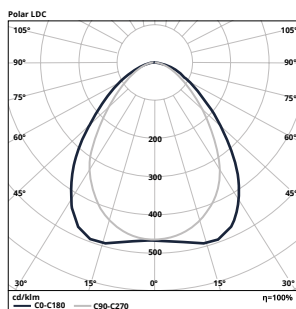

LED Panel Essence 40W 1200 4000K

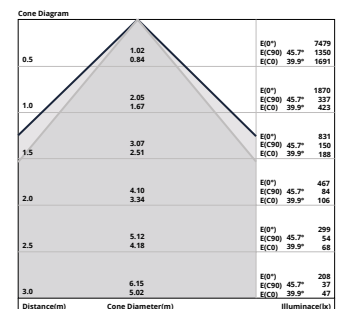
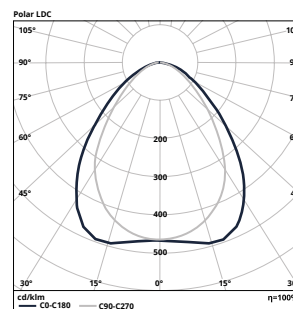

PACKAGING INFORMATION

Item code	Description	Single box		Master carton		
		Dimensions(LxWxH) (mm)	Weight(kg)	Units per master carton	Dimensions(LxWxH) (mm)	Weight(kg)
4600239	LED Panel Essence 40W 600 3000K	625x38x695	2.9	4	710x170x645	12.8
4600246	LED Panel Essence 40W 600 4000K	625x38x695	2.9	4	710x170x645	12.8
4600253	LED Panel Essence 40W 620 3000K	625x38x695	2.9	4	710x170x645	12.8
4600260	LED Panel Essence 40W 620 4000K	625x38x695	2.9	4	710x170x645	12.8
4600277	LED Panel Essence 40W 1200 3000K	1300x38x325	3	4	1315x170x345	13
4600284	LED Panel Essence 40W 1200 4000K	1300x38x325	3	4	1315x170x345	13

PRAGMALUX

All rights reserved. Pragmalux - PDL Lighting Group B.V. retains the right to modify product specifications without any prior notice or obligation and does not assume any liability for any consequences of using this document. Subject to errors and printing errors. Luminous flux tolerance: +/- 10%. Power consumption tolerance: +/- 10%.

Version: August 2019

Item code	Description	Single box		Master carton		
		Dimensions(LxWxH) (mm)	Weight(kg)	Units per master carton	Dimensions(LxWxH) (mm)	Weight(kg)
4600369	LED Panel Surface Mounted Kit 600	605x39x610	1.115	10	625x445x635	12.15
4600376	LED Panel Surface Mounted Kit 620	630x39x635	1.165	10	645x445x650	12.65
4600383	LED Panel Surface Mounted Kit 1200	1202x38x305	1.335	10	1220x445x340	14.45
4600406	LED Panel Surface Mounted Kit Quick 600	607x62x610	2.3	4	620x270x630	10.2
4600413	LED Panel Surface Mounted Kit Quick 620	632x62x635	2.4	4	655x275x645	10.6
4600420	LED Panel Surface Mounted Kit Quick 1200	1210x62x307	2.65	4	1220x270x330	11.9
4600437	LED Panel Suspension Kit	120x100x50	1.75	50	355x285x147	9.5
4600444	LED Panel Mounting Clips 600/620 (4pcs)	120x100x50	1.3	40	220x210x160	4.5
4600451	LED Panel Safety Cable 1M	100x70x10	0.025	100	220x210x160	4.75

APPLICATIONS

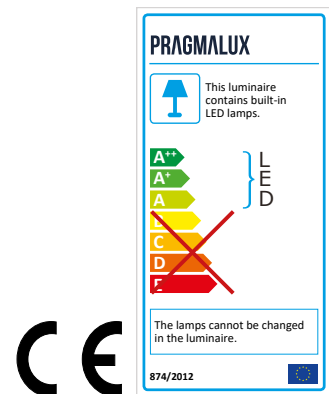
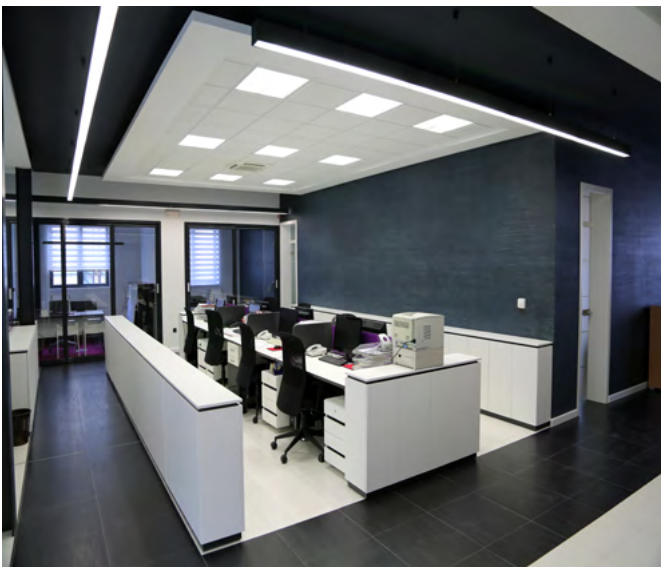

PRAGMALUX

All rights reserved. Pragmalux - PDL Lighting Group B.V. retains the right to modify product specifications without any prior notice or obligation and does not assume any liability for any consequences of using this document. Subject to errors and printing errors. Luminous flux tolerance: +/- 10%. Power consumption tolerance: +/- 10%.

Version: August 2019