

green:ID
Venus

LED OFFICE FLOOR LAMP

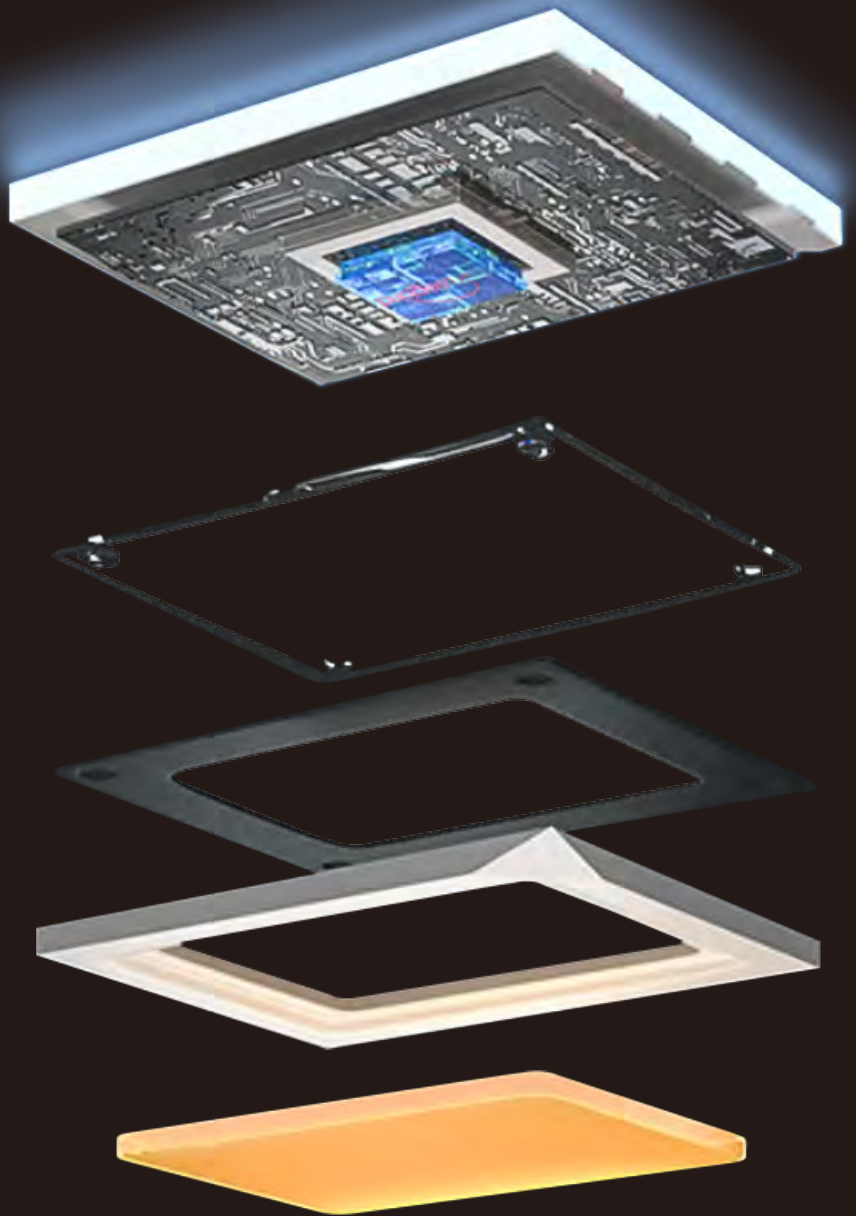



SUNLIKE LED

Close to pure daylight spectrum

Less visual fatigue

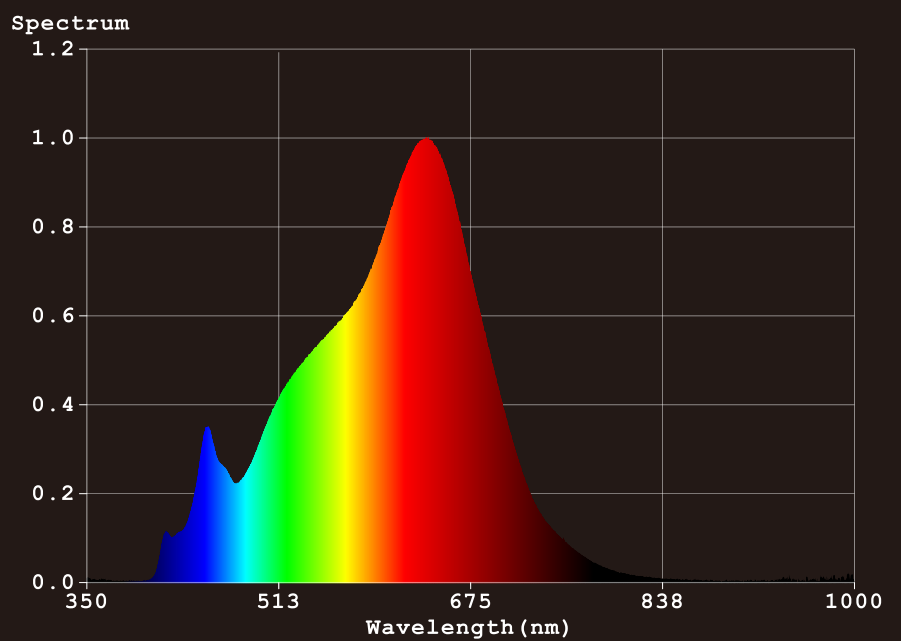

HIGH CRI

Better color recognition

Thanks to the benefit of advanced LED ,vitality of the swaying tulip can be delicately presented

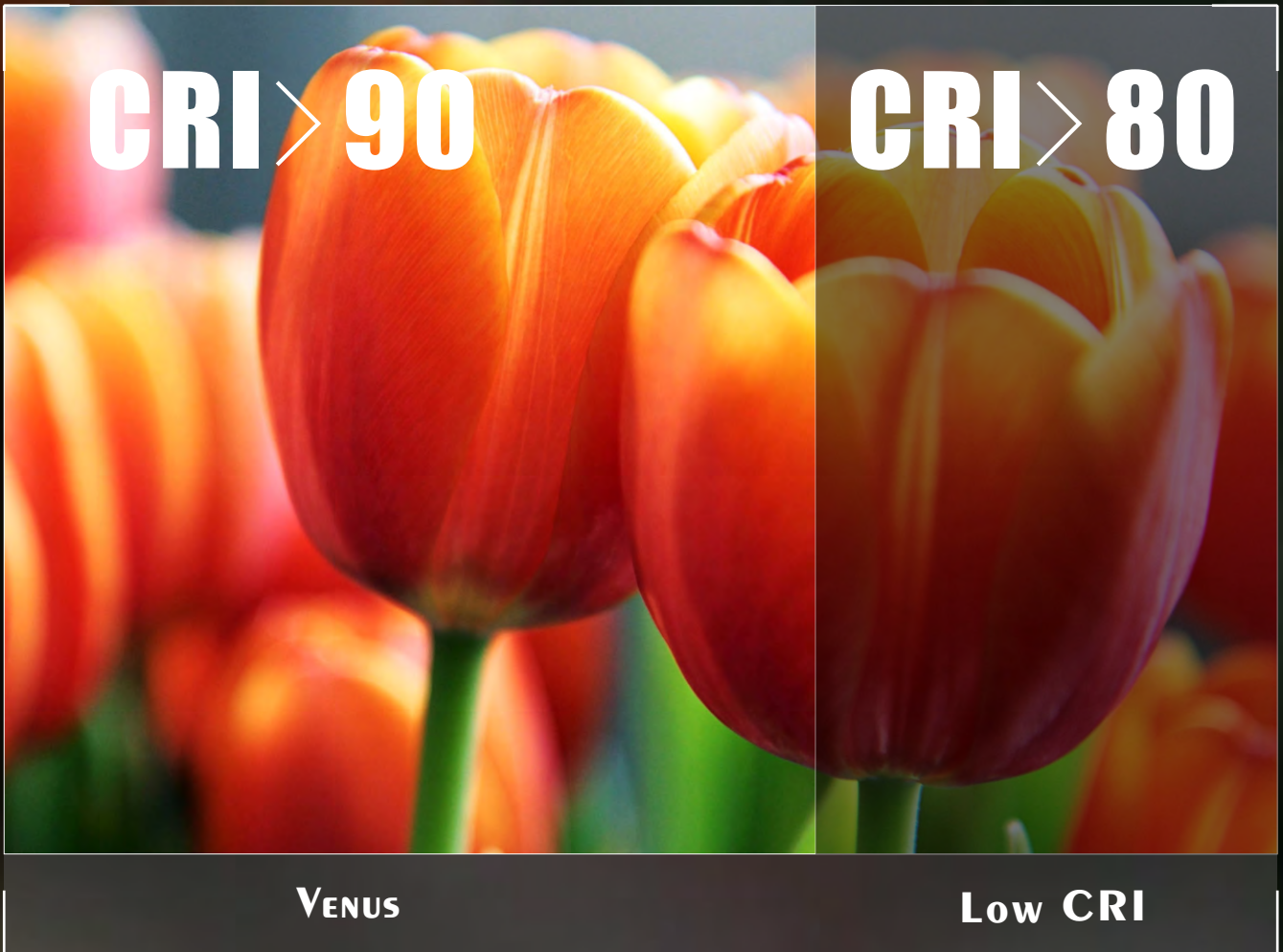

LOW GLARE

Advanced Recessed reflectors

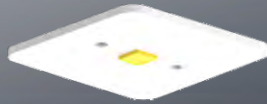

LED Chips



Holder



Secondary Optics



Anti-glaring parts

UGR < 13

- Less visual fatigue
- Higher working efficiency

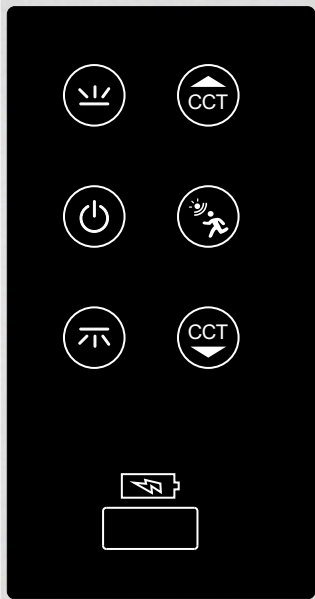

CONNECTION

- Two poles connected into one pole
- Smaller packing volume
- Easier for transportation

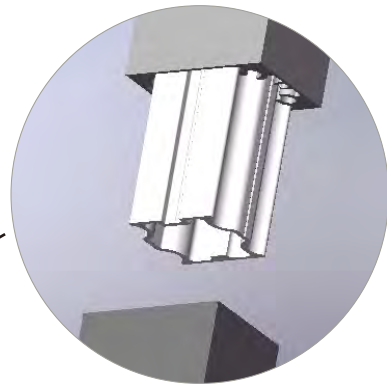

CONNECTION JOINT



ROTATABLE

Choose just right



SPACE LIGHTING

Direct & Indirect lighting combined

Create a homogeneous lighting

↑ 66W

Indirect light

Direct light

↓ 34W



CCT TUNABLE

Independent CCT tunable for up/down luminaire



SENSING

① Motion sensing

Max motion range: 7m

Motion & Daylight sensing



② Daylight harvest

various threshold value selectable



550lx



500lx



450lx



400lx



350lx



300lx



250lx



200lx



150lx



100lx

USB CHARGING



FLICKER-FREE

No visual flicker



DETAILS



Reflector

Advanced recessed reflector,
UGR<13

Key switch

Phase dimming & CCT tuning

Aviation AI

Strong pole to hold whole luminaire

Sturdy base

Up to 9.5kg, sturdy for whole luminaire

KEY SWITCH

Easy & Clear

Dimming
Upwards luminaire

On/off button
For whole luminaire

Dimming
Downwards luminaire

CCT tuning
Upwards luminaire

Motion & Daylight sensing
On/off

CCT tuning
Downwards luminaire

Charging port
5V USB charging

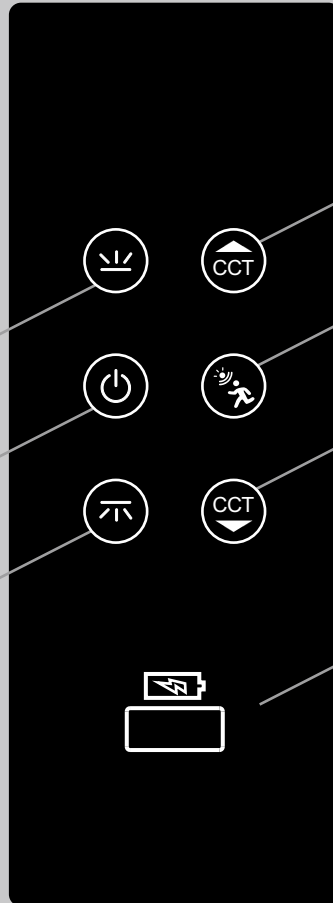

Short press for phase dimming
Long press 3s to turn off upwards luminaire



Short press to turn on/off whole luminaire



Short press for phase dimming
Long press 3s to turn off downwards luminaire



Short press for CCT switch of upwards luminaire
2700K-4000K-6500K phase switch



Short press to turn on/off motion sensing
Upwards luminaire flash once means motion sensing
turned on and if flash three times means turned off

Long press 3s to turn on/off daylight sensing
Downwards luminaire flash once means daylight sensing
turned on and if flash three times means turned off



Short press for CCT switch of downwards luminaire
2700K-4000K-6500K phase switch

DIMENSION

ITEM

PLACE OF ORIGIN

WEIGHT

VANGUARD FREE STANDING LAMP

CHINA

14kg

LUMEN

AC WIRE

POWER

MATERIAL

> 10,000lm

2m

100W

AVIATION ALUMINIUM

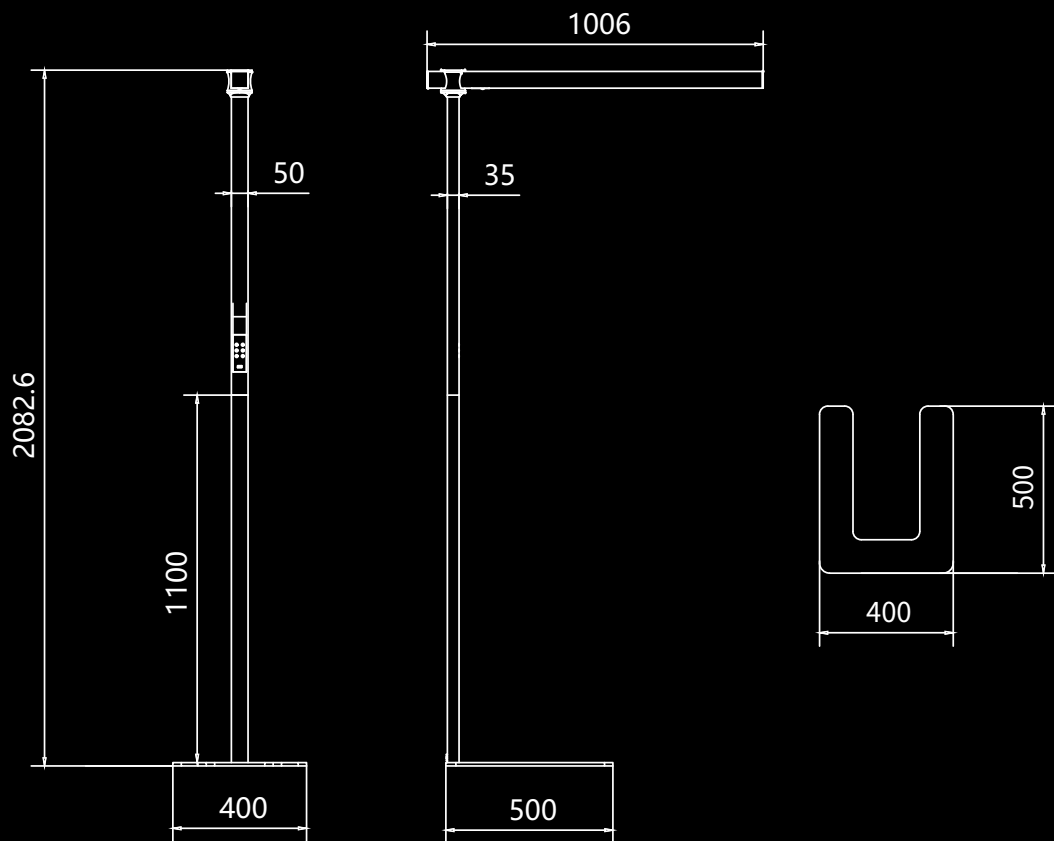

- * Rotatable light head for more flexibility
- * Sunlike LED equipped for better visual comfort and health
- * Recessed reflector for low glare
- * USB charging port, suitable for office
- * CCT switchable, good for reading, work & relax

ACCESSORIES

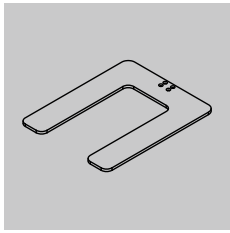

Base

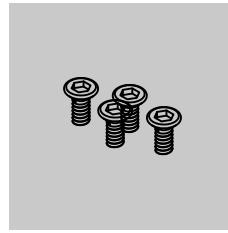

**Countersunk screws
M4*10---4pcs**

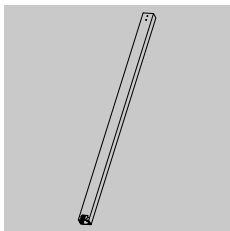

Down pole

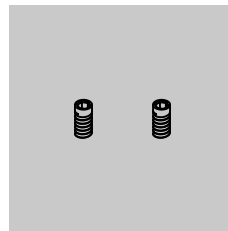

**Inner-hexagon screws
M4*5 ---2pcs**

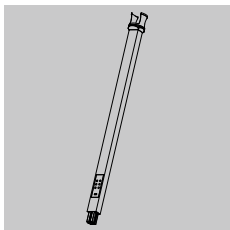

Up pole

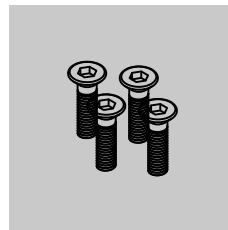

**Countersunk screws
M6*20---4pcs**

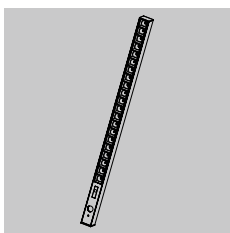

Light module

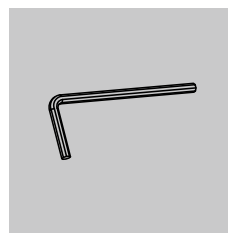

**T Hexagon wrench
Small**

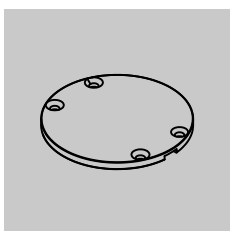

Fixing cap

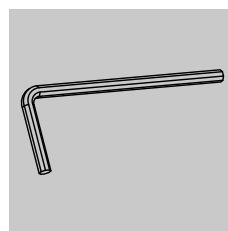

**T Hexagon wrench
Big**

PACKAGING

Much smaller than traditional freestanding lamp

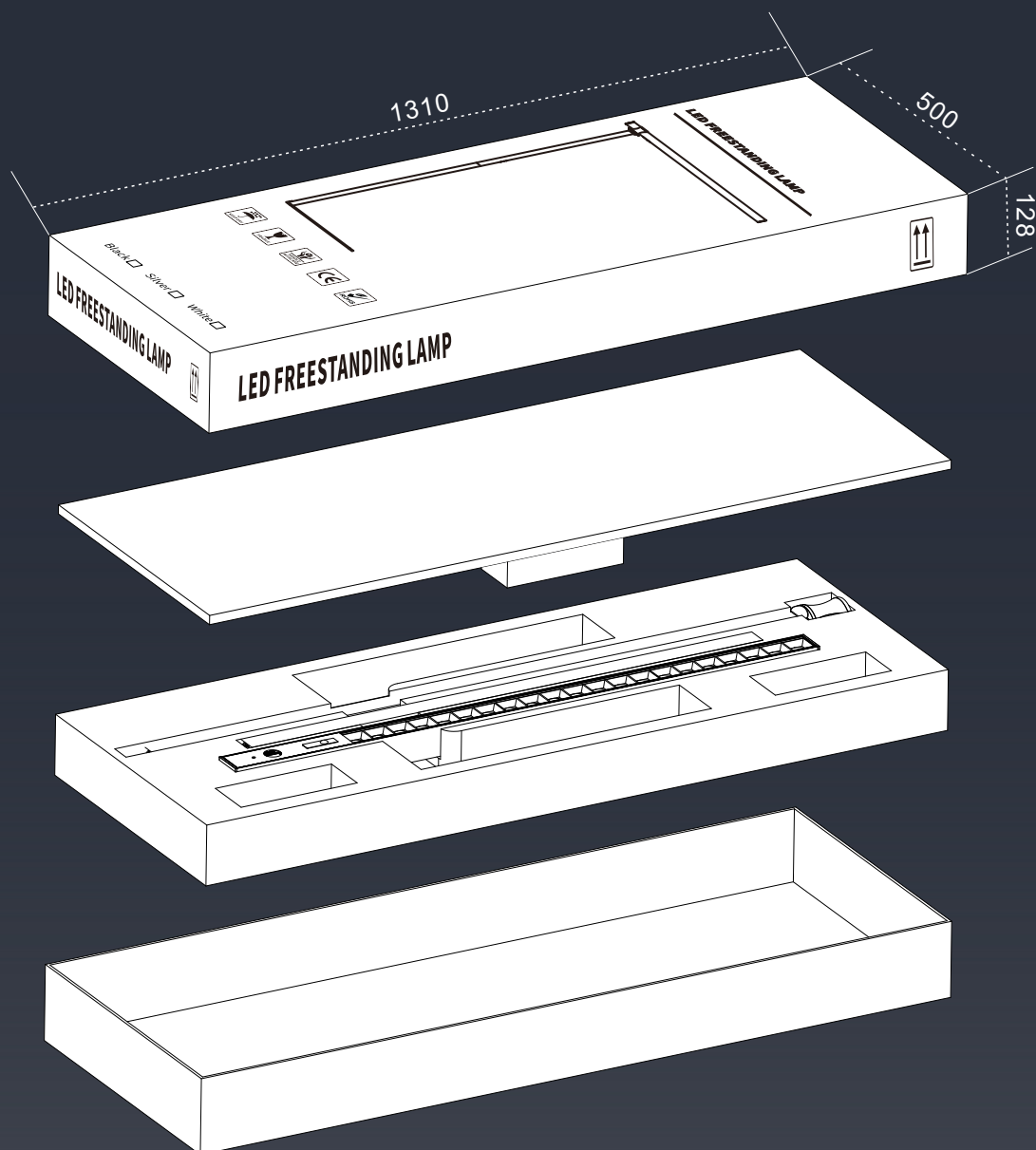

Convenient for all kinds of shipping

APPLICATION



