

Intelligent Tunable White LED Driver (Constant Current)

- Housing made from SAMSUNG/COVESTRO's V0 flame retardant PC materials.
- Ultra small, thin and lightweight, screwless end cap.
- Change the dimming interface, output current, DALI address and other parameters on the NFC programmer or via the App, and sync the parameters to the driver.
- Set the DALI group, scene in the advanced DALI template.
- Set the output current down to 1mA.
- DALI bus standard IEC62386-101, 102, 209.
- Class 2 LED driver, Safety Extra Low Voltage (SELV).
- Soft-on and fade-in dimming function enhances your visual comfort.
- T-PWM™ dimming technology allows quality and high-end lighting.
- The whole dimming process is flicker-free with high frequency exemption level.
- Comply with the EU's ErP Directive, networked standby<0.5W.
- Multiple current levels, wide voltage range, suitable for LEDs with different power
- When there is no load, the output will be 0V to prevent damage to LEDs due to poor contact.
- Overheat, over voltage, overload, short circuit protection and automatic recovery.
- Suitable for Class I / II / III indoor light fixtures.
- Normal service life can reach 100,000 hours.
- 5-year warranty (Rubycon capacitor).



T-PWM™
Dimming Technology

Flicker Free
IEEE 1789

Dimmable:
10000 : 1

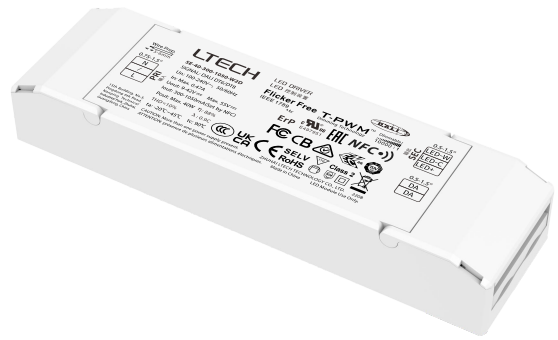

Technical Specs

Model		SE-40-300-1050-W2D	SE-30-200-800-W2D	
Features	Output Type	Constant current		
	Dimming Interface	DALI DT6/DT8		
	Output Feature	Isolation		
	Protection Grade	IP20		
	Insulation Grade	Class II (Suitable for class I / II / III light fixtures)		
OUTPUT	Output Voltage	9-42Vdc		
	Maximum output voltage	≤55Vdc		
	Output Current Range	300-1050mA	200-800mA	
	Output Power Range	2.7W-40W	1.8W-30W	
	Dimming Range	0-100%, down to 0.01%		
	LF Current Ripple	<3%(Maximum current for non dimming state)		
	Current Accuracy	±5%		
	PWM Frequency	≤3600Hz		
INPUT	DC Voltage Range	120-300Vdc		
	AC Voltage Range	100-240Vac		
	Input Voltage	115Vac/230Vac		
	Frequency	50/60Hz		
	Input Current	≤0.45A/115Vac, ≤0.22A/230Vac	≤0.34A/115Vac, ≤0.17A/230Vac	
	Power Factor	PF>0.95/115Vac (at full load), PF>0.9C/230Vac (at full load)		
	THD	THD<10%/230Vac, at full load		
	Efficiency (Typ.)	88%	87%	
	Inrush Current	Cold start 25A[Test twidth=130us tested under 50% Ipeak]/230Vac		
	Anti Surge	L-N: 2KV		
Leakage Current	Max. 0.5mA			
ENVIRONMENT	Working Temperature	ta: -20 ~ 45°C tc: 90°C		
	Working Humidity	20 ~ 95%RH, non-condensing		
	Storage Temperature/Humidity	-40 ~ 80°C/10~95%RH		
	Temperature Coefficient	±0.03%/°C(0-50°C)		
	Vibration	10-500Hz, 2G 12min/1cycle, 72 min for X, Y and Z axes respectively		
PROTECTION	Overload Protection	Automatically protect the device when the load exceeds 102% of the rated power. Automatically recover once load is reduced		
	Overheat Protection	Intelligently adjust or turn off the current output if the PCB temperature ≥110°C. When the PCB temperature <90°C, automatically recover normal output		
	Overvoltage Protection	Automatically protect the device when voltage exceeds the no-load voltage. It can be recovered automatically		
	Short Circuit Protection	Enter hiccup mode if short circuit occurs, and recover automatically		
SAFETY & EMC	Withstand Voltage	I/P-O/P: 3750Vac		
	Insulation Resistance	I/P-O/P: 100MΩ/500VDC/25°C/70%RH		
	Safety Standards	CCC	China	GB19510.1, GB19510.14
		TUV	Germany	EN61347-1, EN61347-2-13, EN62493
		CB	CB Member States	IEC61347-1, IEC61347-2-13
		CE	European Union	EN61347-1, EN61347-2-13, EN62384
		KC	Korea	KC61347-1, KC61347-2-13
		EAC	Russia	IEC61347-1, IEC61347-2-13
		RCM	Australia	AS 61347-1, AS 61347-2-13
		ENEC	Europe	EN61347-1, EN61347-2-13, EN62384
		UKCA	Britain	BS EN 61347-1, BS EN 61347-2-13, BS EN 62493
		BIS	India	IS 15885 (PART 2/SEC 13)
	CUL	Canada	CSA C22.2 NO.250.13	
	UL	America	UL 8750	
	EMC Emission	CCC	China	GB/T17743, GB17625.1
		CE	European Union	EN55015, EN61000-3-2, EN61000-3-3, EN61547
		KC	Korea	KSC 9815, KSC 9547
		EAC	Russia	IEC62493, IEC61547, EH55015
		RCM	Australia	EN55015, EN61000-3-2, EN61000-3-3, EN61547
		UKCA	Britain	BS EN IEC 55015, BS EN IEC 61000-3-2, BS EN 61000-3-3, BS EN 61547
CUL		Canada	ICES-005	
UL		America	FCC PART 15B	
EMC Immunity	EN61000-4-2,3,4,5,6,8,11, EN61547			
ErP	Power Consumption	Networked standby	<0.5W (After shutdown by command)	
		No-load power consumption	<0.5W (When the lamp is not connected)	
	Flicker/Stroboscopic Effect	IEEE 1789	Meet IEEE 1789 standard/High frequency exemption level	
		CIE SVM	Pst LM≤1.0, SVM≤0.4	
OTHERS	DF	Phase factor	DF≥0.9	
	Weight(N.W.)	170g±10g	150g±10g	
	Dimensions	142×40×23mm(L×W×H)		

Product Size

Unit: mm

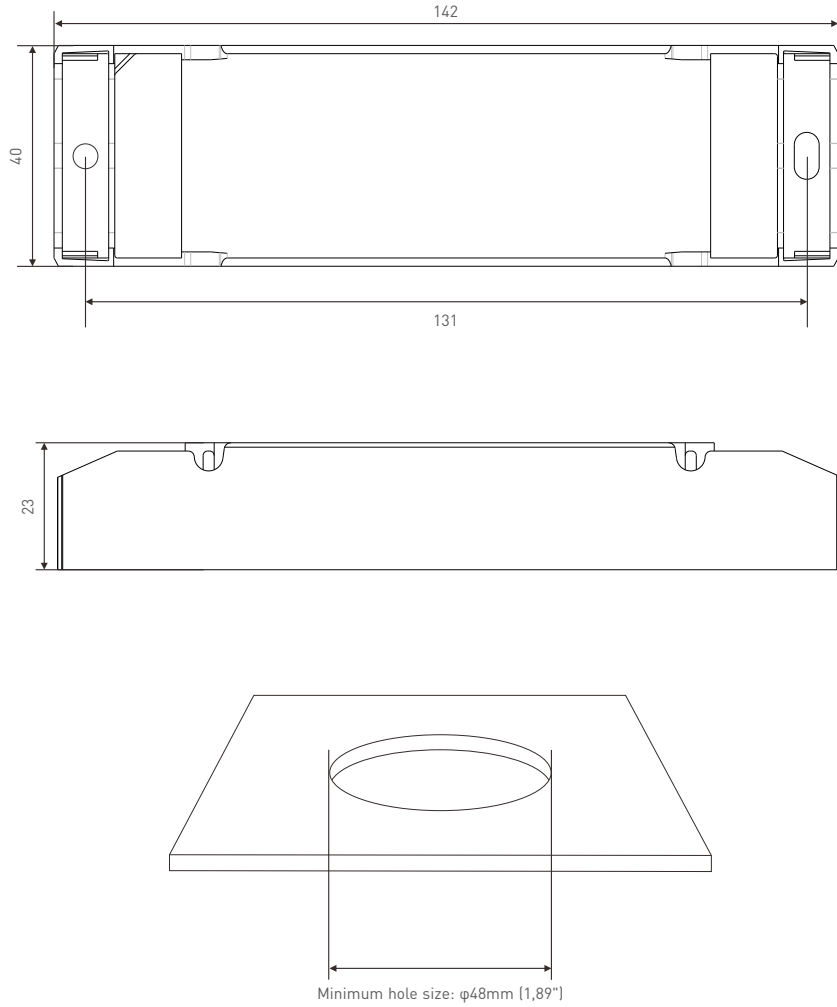

Wiring Diagram

DALI Connection

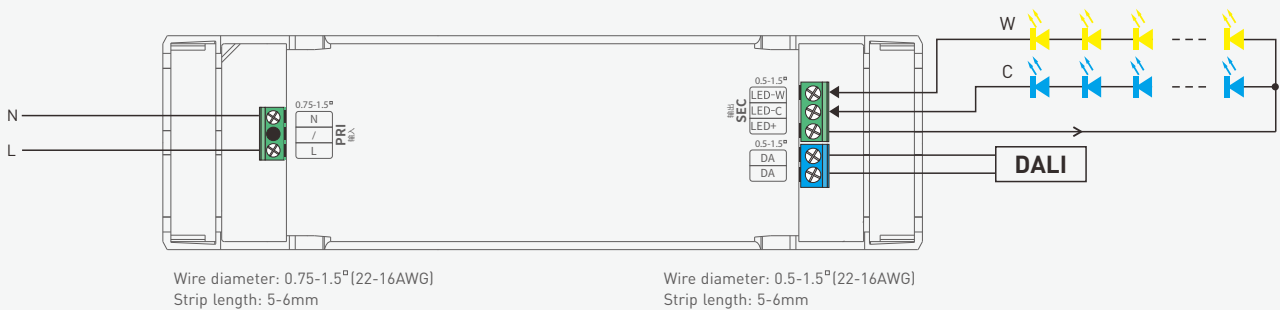

Dimming: 0-100%
Color temperature: 1000-10000K

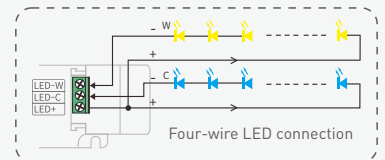

* Adopting constant power program design, it keeps the same brightness in color temperature dimming, and twice the rated power load can be connected.
e.g. A 40W driver can connect to 40W X 2CH load, but the total power of the 2 channels will be kept in 40W

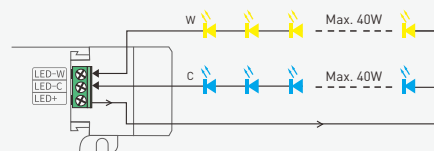

Current and Parameters Sheet

Set output current on the NFC programmer or via the App			
SE-40-300-1050-W2D	Output Current (I) Range	300-952mA	953-1050mA
	Output Voltage (U) Range	9-42Vdc	See the curve below for details
	Output Power (P) Range	2.7-40W	8.577-40W

Set output current on the NFC programmer or via the App			
SE-30-200-800-W2D	Output Current (I) Range	200-714mA	715-800mA
	Output Voltage (U) Range	9-42Vdc	See the curve below for details
	Output Power (P) Range	1.8-30W	6.435-30W

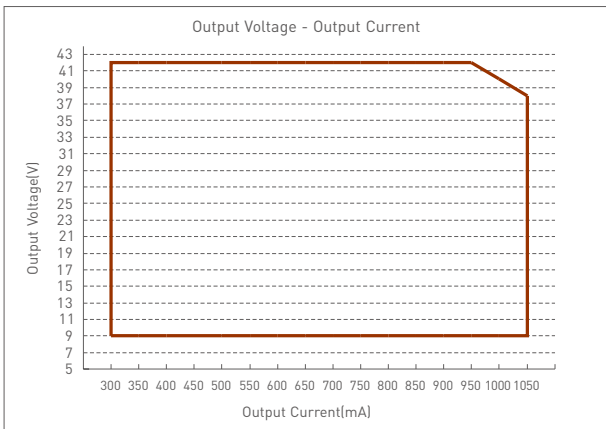

SE-40-300-1050-W2D

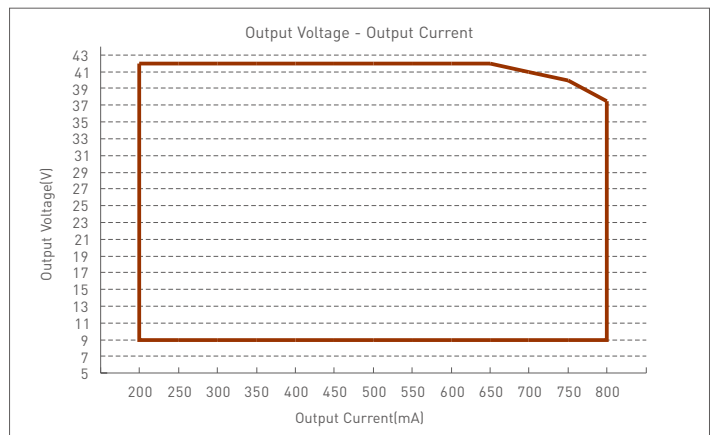

SE-30-200-800-W2D

Protective Housing Application Diagram

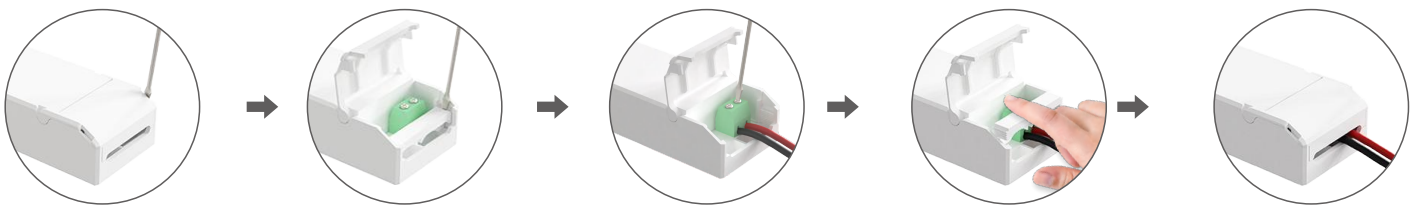

1. Use a tool to pry up the protective housing on the side panel.

2. Pry up the protective housing in the side plate position with a tool.

3. Connect to electrical wires with a screwdriver as wiring diagram shows.

4. Press down the tension plate to fix the the electrical wires.

5. Close the protective housing.

Installation Precautions

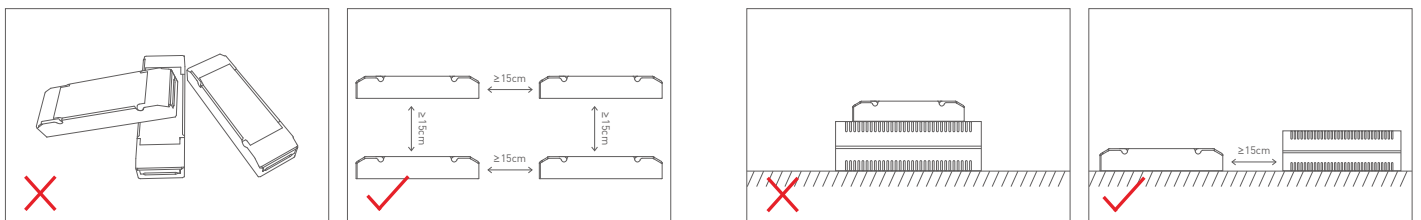

Please do not stack the products. The distance between two products should be $\geq 15\text{cm}$ so as not to affect heat dissipation and the lifespan of the products.

Please not place the products on LED drivers. The distance between the product and the driver should be $\geq 15\text{cm}$ so as not to affect heat dissipation and shorten the lifespan of the products.

Work with a NFC programmer (LT-NFC)

Change the output current, DALI address and other parameters on the NFC programmer. After modification, batch parameters can be written to the driver.

* Before you begin setting the parameters of the driver on the NFC programmer, please make sure the driver is powered off.

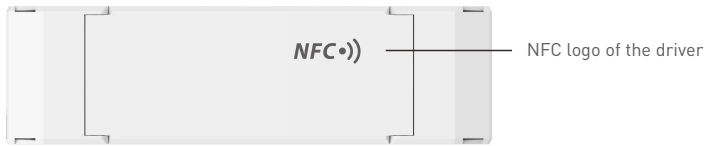

1. Read the LED driver

Power the programmer by using the USB cable, then select "NFC Driver Settings" and press "OK" button. Next, keep the programmer's sensing area close to the NFC logo of the driver to read the driver parameters.

2. Change the driver parameters (Output current/DALI address)

On the home page of the programmer, press "▲▼" button to select the parameters you want to change and press the "OK" button to edit them. Then, press "▲▼" button to adjust the parameter values and press "◀▶" to select the next needed value. After the parameter values are modified, save them by pressing the "OK" button.

Note: (1) If the current value you set is out of range, The programmer will report an error; (2) The DALI address range :0-63.

3. Write to the driver

On the home page of the programmer, press the "▲▼" button to select [>Ready to Write], then press the "OK" button. After the screen displays "Ready to write...", please keep the programmer's sensing area close to the NFC logo of the driver. When the screen displays "Write succeeded", it means the parameters have been successfully changed.

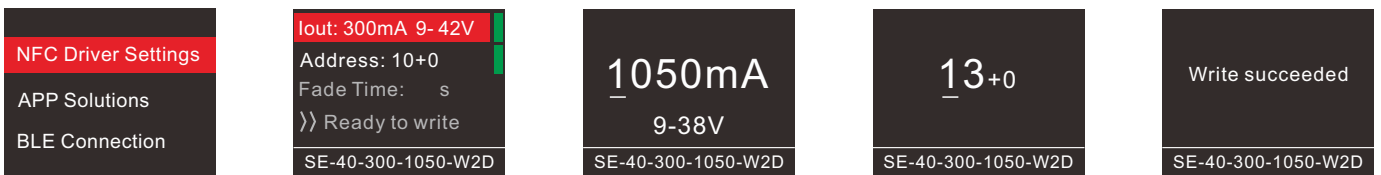

Use the NFC Lighting APP

Scan the QR code below with your mobile phone and follow the prompts to complete the APP installation (According to performance requirements, you need to use a NFC-capable Android phone, or an iPhone 8 and later that are compatible with iOS 13 or higher).



* Before you begin setting the parameters of the driver on the NFC programmer or via the APP, please make sure the driver is powered off.

Read/Write the LED driver

Use your NFC-capable phone to read the driver parameters, then set the output current, DALI address, other parameters, or set the advanced DALL template depending your needs. Save your settings and hold your phone close to the driver again, so the parameters can be easily written to the driver.

1. Read the LED driver

On the APP home page, click [Read/Write LED driver], then keep the programmer's sensing area close to the NFC logo of the driver to read the driver parameters.

2. Switch the dimming interface

On the page of "Edit parameters", click [Dimming interfaces] to switch to the needed dimming interface: DT8 CT (DT8 1 channel), DT6 CT (DT6 2 channels), DT6 DIM (1 address for 1 channel / 1 address for 2 channels / 2 addresses for 2 channels).

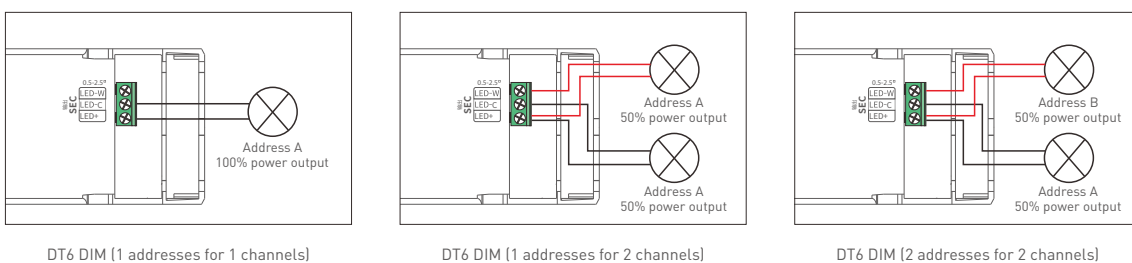

3. Edit the parameters

Click **[Parameter settings]** to edit the advanced parameters, like output current, DALI address, dimming curve, advanced DALI template, etc.

4. Write to the driver

After completing the parameter settings, click **[Write]** in the upper right corner, and keep the programmer's sensing area close to the NFC logo of the driver, so the parameters can be written to the driver.

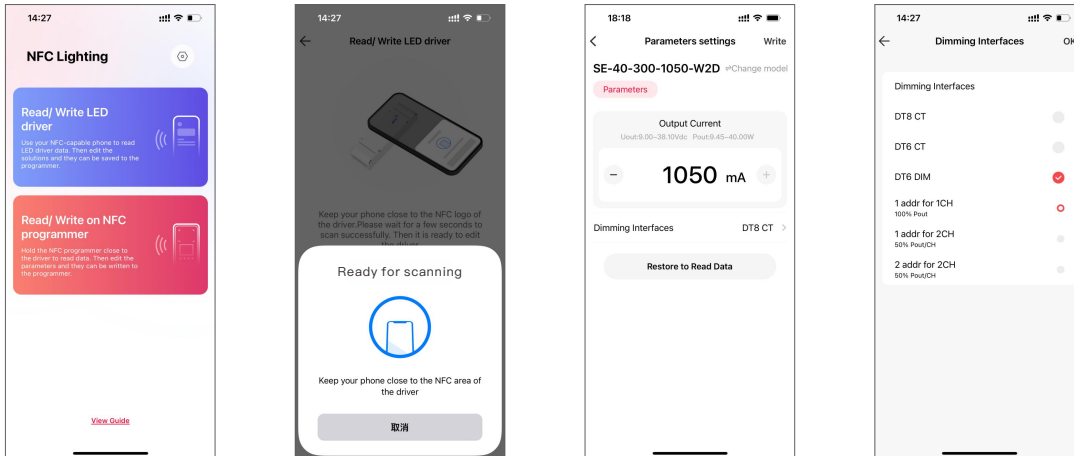

Write/Read on the NFC programmer

Connect the NFC programmer to your phone and read the driver parameters with your phone. After editing the solution in the mobile App, you can sync it to the NFC programmer and write advanced parameters to mass LED drivers.

1. Connect to the NFC programmer

Enable Bluetooth on your phone and power the NFC programmer first. Then press the button on the programmer to switch to "BLE Connection" and press "OK" button to wait for Bluetooth connection. On the APP home page, click **[Write/Read on NFC programmer]** — **[Next]** to search for the programmer and connect to it.

2. Read the LED driver

On the "Programmer information" page, choose any solution for editing. Then keep the programmer's sensing area close to the NFC logo of the driver, to read the driver parameters.

3. Switch the dimming interface

On the page of "Edit parameters", click **[Dimming interfaces]** to switch to the needed dimming interface: DT8 CT (DT8 1 channel), DT6 CT (DT6 2 channels), DT6 DIM (1 address for 1 channel / 1 address for 2 channels / 2 addresses for 2 channels).

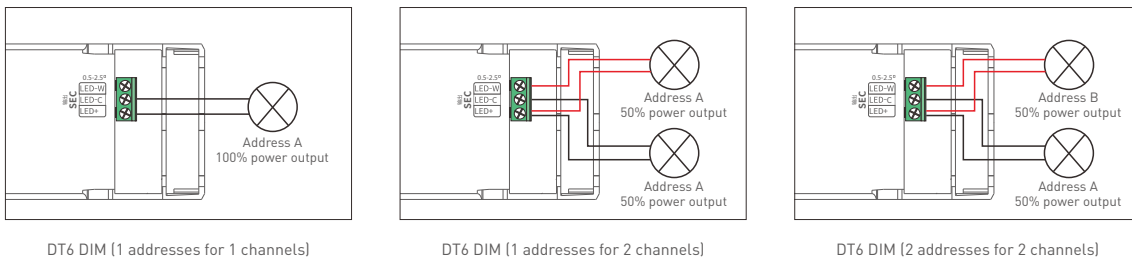

4. Edit the parameters

Click **[Parameter settings]** to edit the advanced parameters, like output current, DALI address, dimming curve, advanced DALI template, etc. Then click **[Save]** in the top right.

5. Write to the LED driver

When the programmer screen shows "Sync ... succeeded", click "BACK" button to return to the home page and switch to the "APP Solutions", then press the "OK" button to access the optional solutions. Select the corresponding solution by pressing the "◀▶" button, then keep the programmer's sensing area close to the NFC logo of the driver. After this, the advanced solution can be written to a large number of the same model drivers.

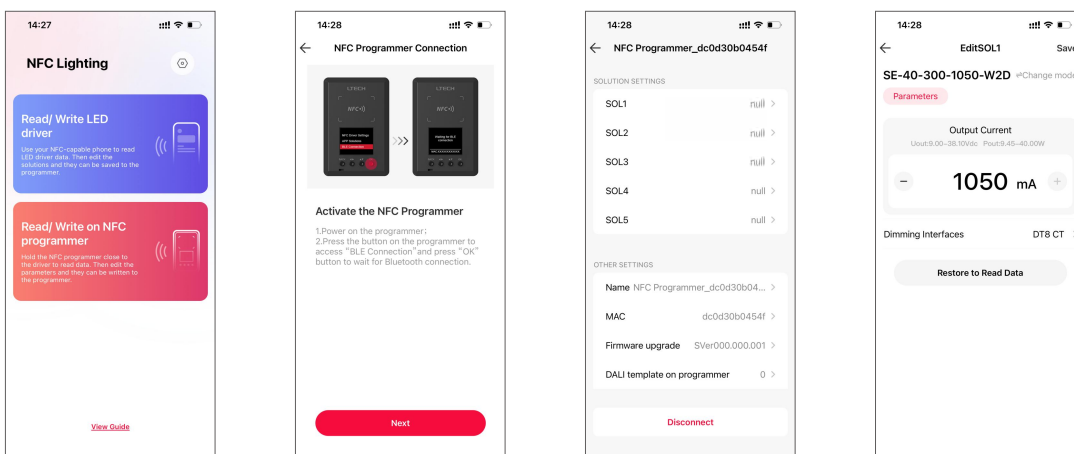

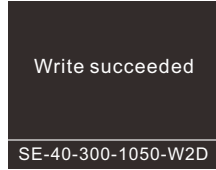
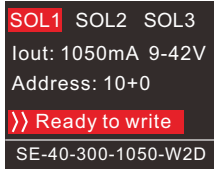
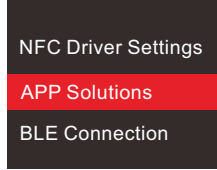
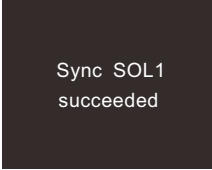

Advanced DALI template

Integrate the functions of the DALI lighting system, edit the DALI group and lighting effects for scenes, then save them in the advanced template to achieve lighting programming.

Setup page 1 (for Read/Write LED driver) : Go to App home page — [🔗] icon in the top right — [DALI template on phone] .

Setup page 2 (for Read/Write on NFC programmer): Go to App home page — [Read/Write on NFC programmer] — [DALI template on programmer] .

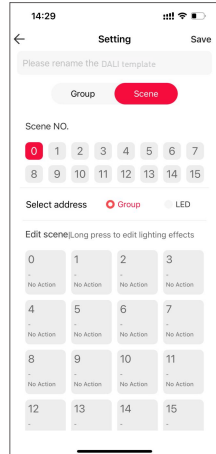
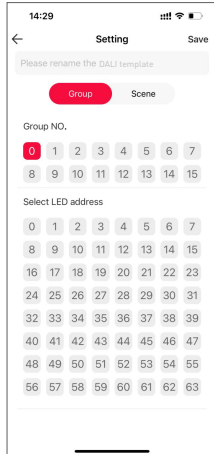
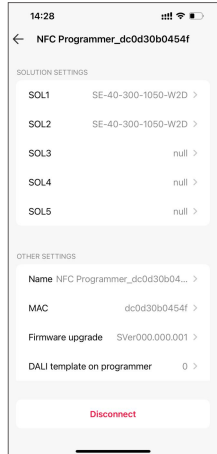
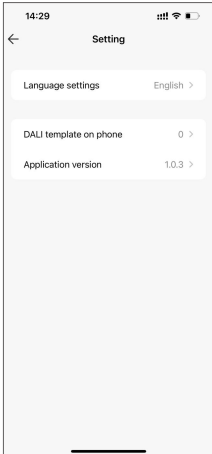

For more advanced solution settings, please scan the QR code below and check out the NFC programmer manual (model: LT-NFC).

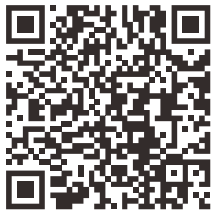

Relationship Diagrams

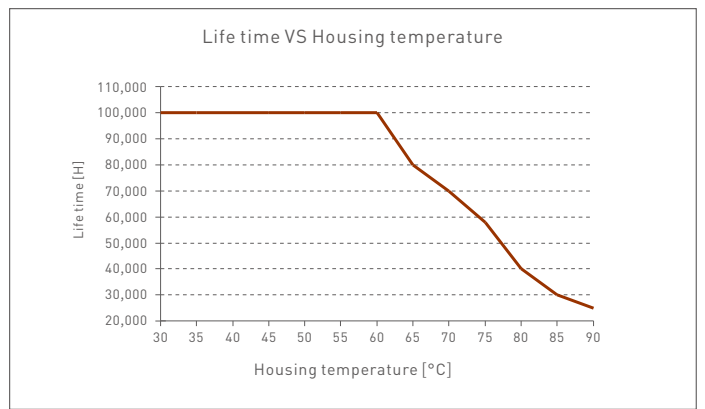
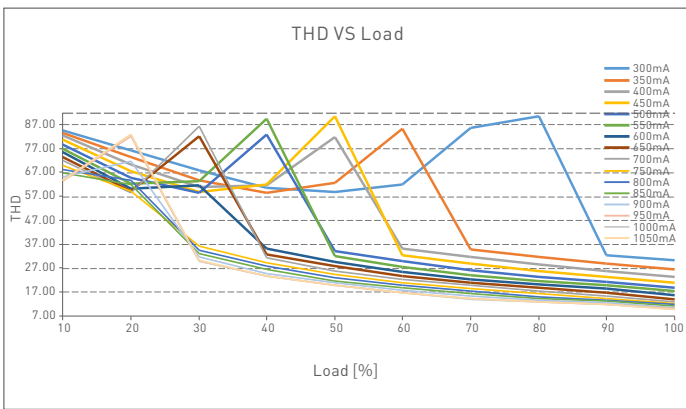
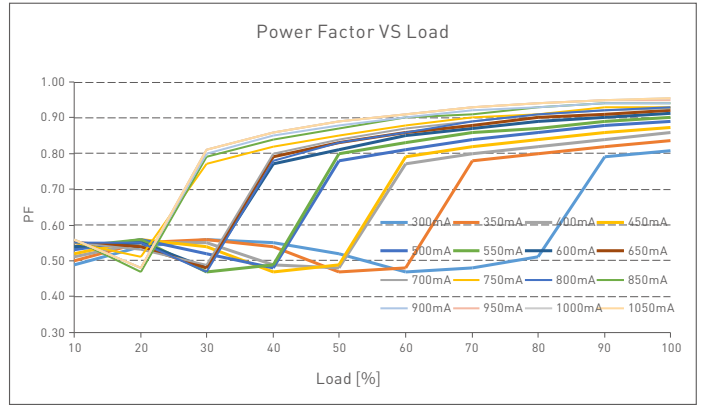
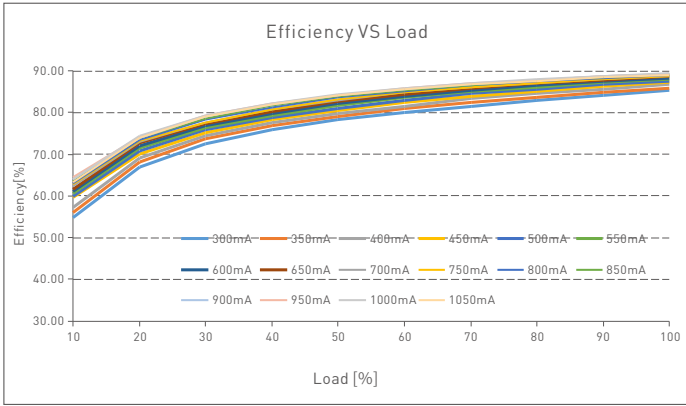

SE-40-300-1050-W2D

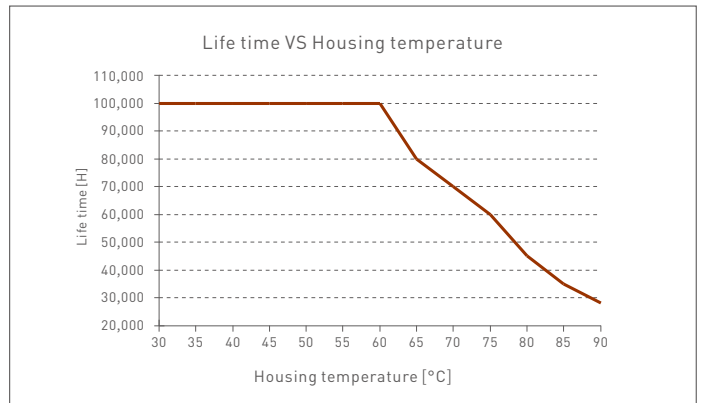
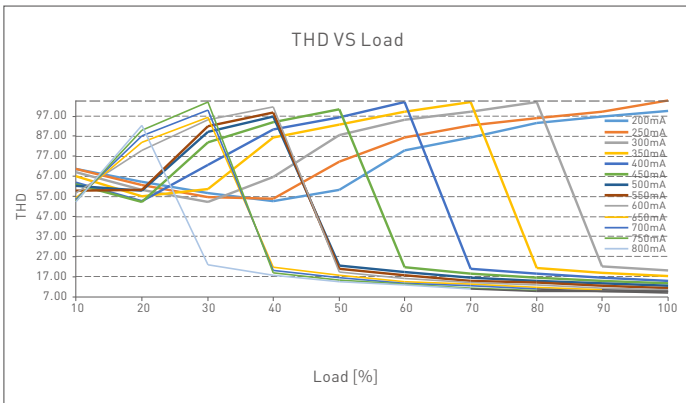
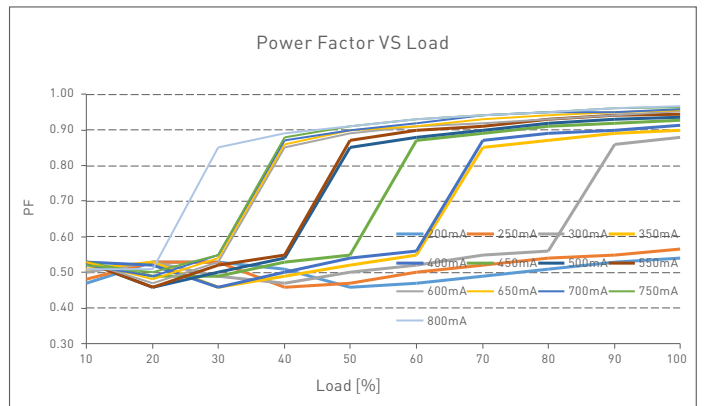
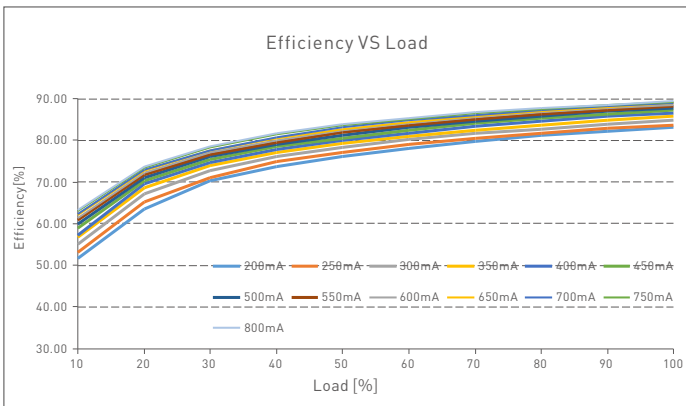

SE-30-200-800-W2D

Flicker Test Sheet

IEEE 1789

Limit of modulation in low risk area	
Waveform frequency of optical output	limit (%)
$f \leq 8\text{Hz}$	0.2
$8\text{Hz} < f \leq 90\text{Hz}$	$0.025 \times f$
$90\text{Hz} < f \leq 1250\text{Hz}$	$0.08 \times f$
$f > 1250\text{Hz}$	Exemption assessment
Limit of modulation in no effect area	
Waveform frequency of optical output	limit (%)
$f \leq 10\text{Hz}$	0.1
$10\text{Hz} < f \leq 90\text{Hz}$	$0.01 \times f$
$90\text{Hz} < f \leq 3125\text{Hz}$	$[0.08/2.5] \times f$
$f > 3125\text{Hz}$	Exemption assessment [High frequency exemption]

- Brightness
- ▲ 0.1%
 - ▲ 1%
 - ▲ 5%
 - ▲ 10%
 - 20%
 - ▲ 30%
 - 40%
 - ★ 50%
 - 60%
 - 70%
 - 80%
 - ★ 90%
 - ◆ 100%

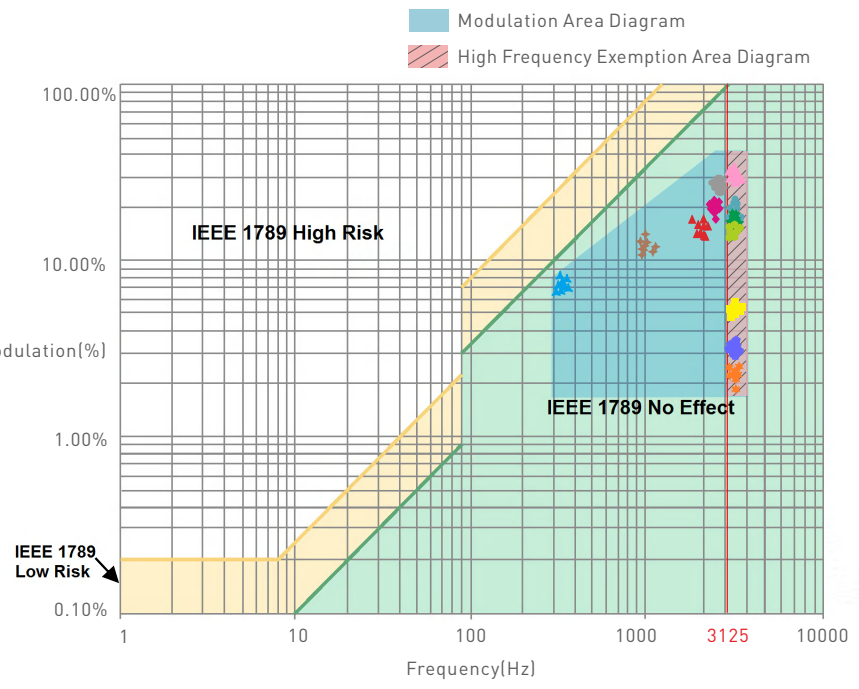

Marks in the right chart were tested results of different current ranges. The output frequency is 0Hz in 100% brightness and its corresponding modulation is 0%, which could not be shown in the right chart.

Packaging Specifications

Model	SE-40-300-1050-W2D	SE-30-200-800-W2D
Carton Dimensions	320×275×106mm(L×W×H)	320×275×106mm(L×W×H)
Quantity	20 PCS/Layer; 2 Layers/Carton; 40 PCS/Carton	20 PCS/Layer; 2 Layers/Carton; 40 PCS/Carton
Weight	0.17 kg/PC; 7.6 kg±5%/Carton	0.15 kg/PC; 6.8 kg±5%/Carton

Packaging Image

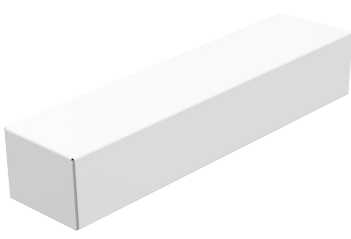

Inner Packaging Box



Carton Packaging

Transportation and Storage

1. Transportation

Products can be shipped via vehicles, boats and planes.

During transportation, products should be protected from rain and sun. Please avoid severe shock and vibration during the loading and unloading process.

2. Storage

The storage conditions should comply with the Class I Environmental Standards. The products that have been stored for more than six months are recommended to be re-inspected and can be used only after they have been qualified.

Attentions

- This product must be installed and adjusted by a qualified professional.
- This product is non-waterproof (special models excepted). Please avoid the sun and rain. When installed outdoors, please ensure it is mounted in a water proof enclosure.
- Good heat dissipation will extend the life the product. Please install the product in a environment with good ventilation.
- When you install this product, please avoid being near a large area of metal objects or stacking them to prevent signal interference.
- Please keep the product away from a intense magnetic field, a high pressure area or a place where lightning is easy to occur.
- Please check whether the working voltage used complies with the parameter requirements of the product.
- Before you power on the product, please make sure all the wiring is correct in case of incorrect connection that may cause a short circuit and damage the components, or trigger a accident.
- If a fault occurs, please do not attempt to fix the product by yourself. If you have any question, please contact the supplier.

* This manual is subject to changes without further notice. Product functions depend on the goods. Please feel free to contact our official distributors if you have any question.

Warranty Agreement

- Warranty periods from the date of delivery: 5 years.
- Free repair or replacement services for quality problems are provided within warranty periods.

Warranty exclusions below:

- Beyond warranty periods.
- Any artificial damage caused by high voltage, overload, or improper operations.
- Products with severe physical damage.
- Damage caused by natural disasters and force majeure.
- Warranty labels and barcodes have been damaged.
- No any contract signed by LTECH.

1. Repair or replacement provided is the only remedy for customers. LTECH is not liable for any incidental or consequential damage unless it is within the law.
2. LTECH has the right to amend or adjust the terms of this warranty, and release in written form shall prevail.

Update Log

Version	Updated Time	Update Content	Updated by
A0	2022.10.09	Original version	Liu Weili