

# green:ID **Venus**

LED OFFICE FLOOR LAMP

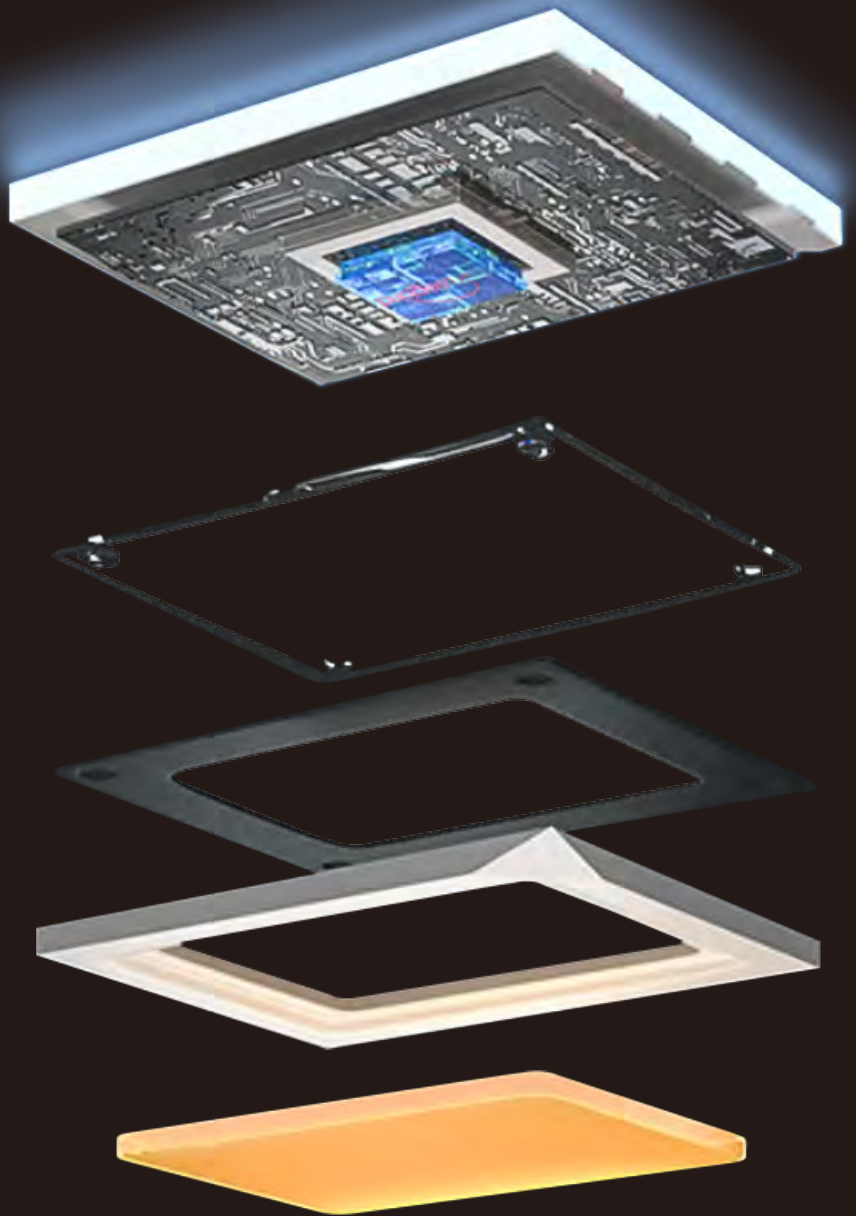



# SUNLIKE LED

Close to pure daylight spectrum

Less visual fatigue

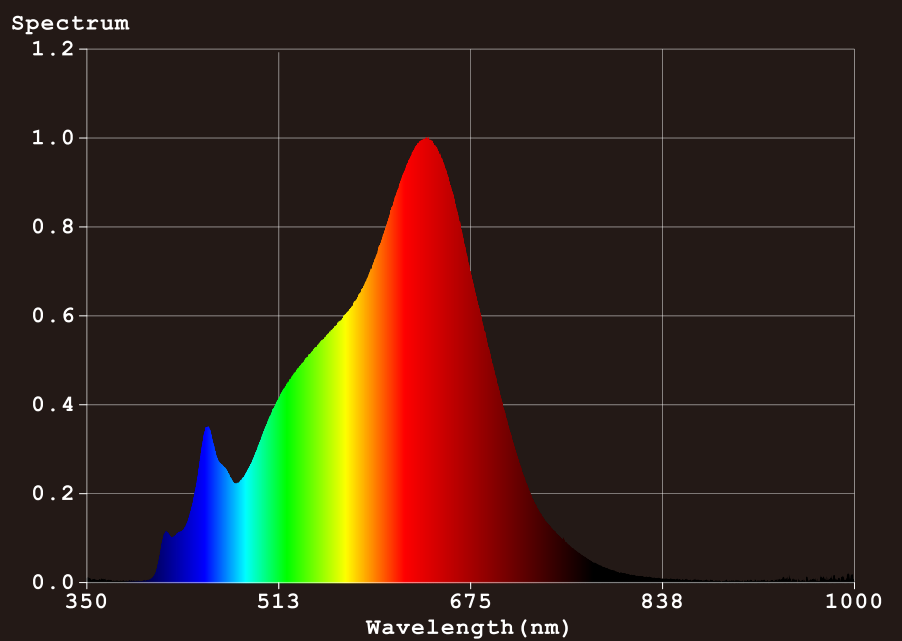

# HIGH CRI

---

Better color recognition

Thanks to the benefit of advanced LED ,vitality of the swaying tulip can be delicately presented



**CRI > 90**

**CRI > 80**

**VENUS**

**Low CRI**

# LOW GLARE

Advanced Recessed reflectors

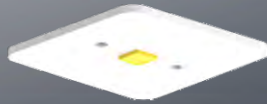

LED Chips



Holder



Secondary Optics



Anti-glaring parts

## UGR < 13

- Less visual fatigue
- Higher working efficiency

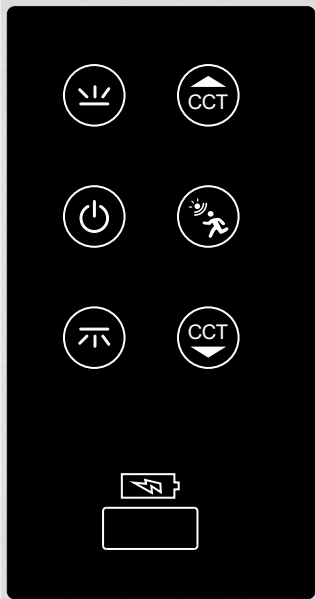

# CONNECTION

---

- Two poles connected into one pole
- Smaller packing volume
- Easier for transportation

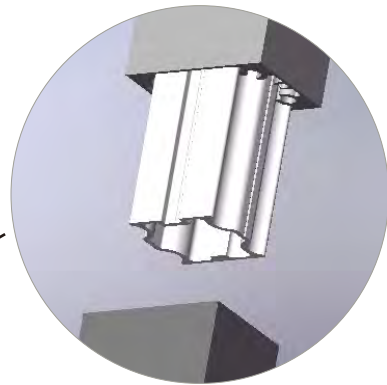

**CONNECTION JOINT**



# ROTATABLE

Choose just right



# SPACE LIGHTING

Direct & Indirect lighting combined

Create a homogeneous lighting

↑ 66W

Indirect light

Direct light

↓ 34W



## CCT TUNABLE

Independent CCT tunable for up/down luminaire



# SENSING

## ① Motion sensing

Max motion range: 7m

Motion & Daylight sensing

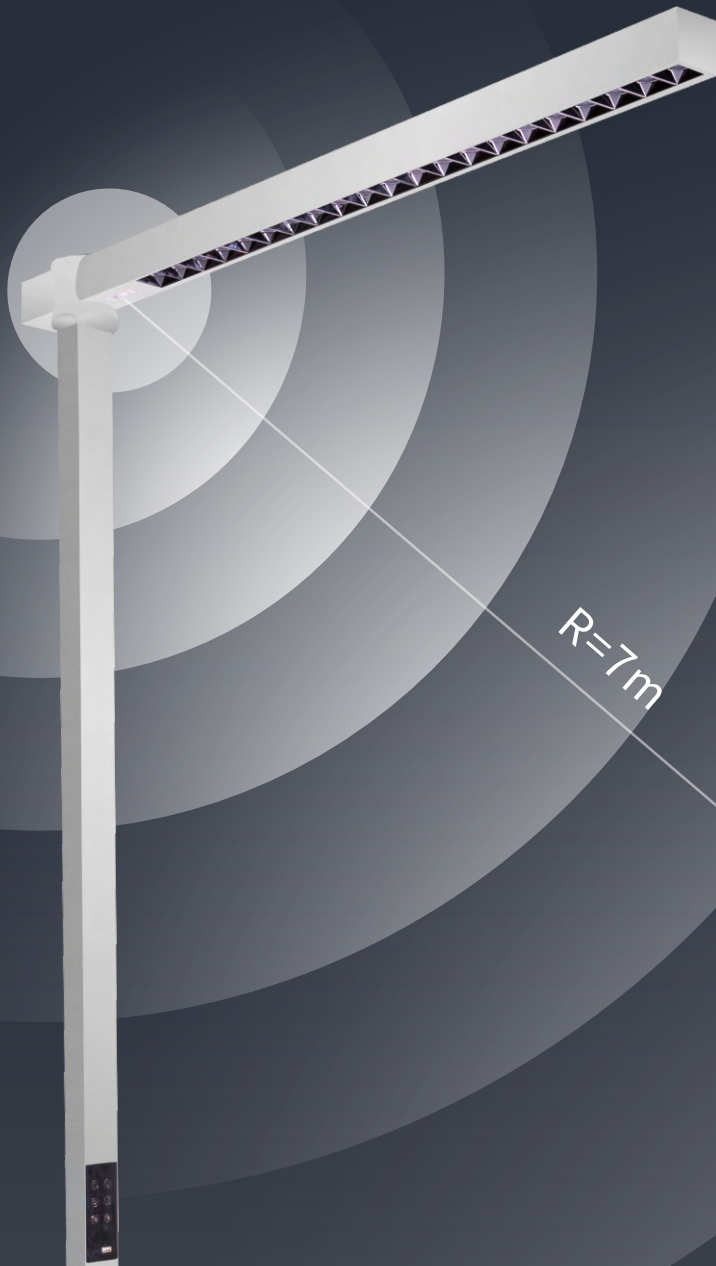

## ② Daylight harvest

various threshold value selectable



550lx



500lx



450lx



400lx



350lx



300lx



250lx



200lx



150lx



100lx



# USB CHARGING



# FLICKER-FREE

---

No visual flicker



# DETAILS

## Reflector

Advanced recessed reflector,  
UGR<13

## Key switch

Phase dimming & CCT tuning

## Aviation AI

Strong pole to hold whole luminaire

## Sturdy base

Up to 9.5kg, sturdy for whole luminaire



# KEY SWITCH

Easy & Clear

**Dimming**  
Upwards luminaire

**On/off button**  
For whole luminaire

**Dimming**  
Downwards luminaire

**CCT tuning**  
Upwards luminaire

**Motion & Daylight sensing**  
On/off

**CCT tuning**  
Downwards luminaire

**Charging port**  
5V USB charging

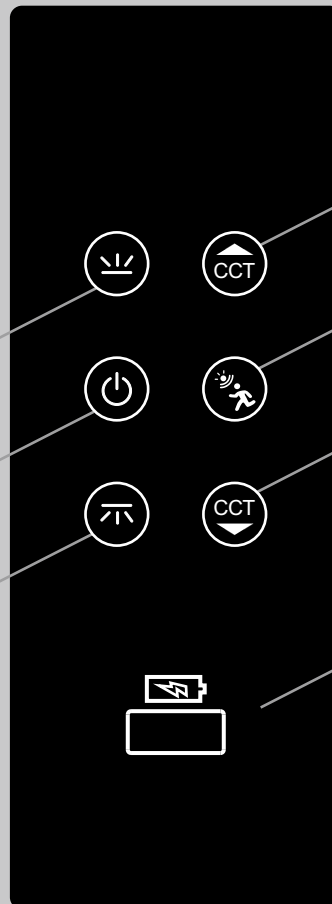

 Short press for phase dimming  
Long press 3s to turn off upwards luminaire

 Short press to turn on/off whole luminaire

 Short press for phase dimming  
Long press 3s to turn off downwards luminaire

 Short press for CCT switch of upwards luminaire  
2700K-4000K-6500K phase switch

Short press to turn on/off motion sensing  
Upwards luminaire flash once means motion sensing  
turned on and if flash three times means turned off

 Long press 3s to turn on/off daylight sensing  
Downwards luminaire flash once means daylight sensing  
turned on and if flash three times means turned off

 Short press for CCT switch of downwards luminaire  
2700K-4000K-6500K phase switch

# DIMENSION

**ITEM**

**PLACE OF ORIGIN**

**WEIGHT**

**VANGUARD FREE STANDING LAMP**

**CHINA**

**14kg**

**LUMEN**

**AC WIRE**

**POWER**

**MATERIAL**

**> 10,000lm**

**2m**

**100W**

**AVIATION ALUMINIUM**

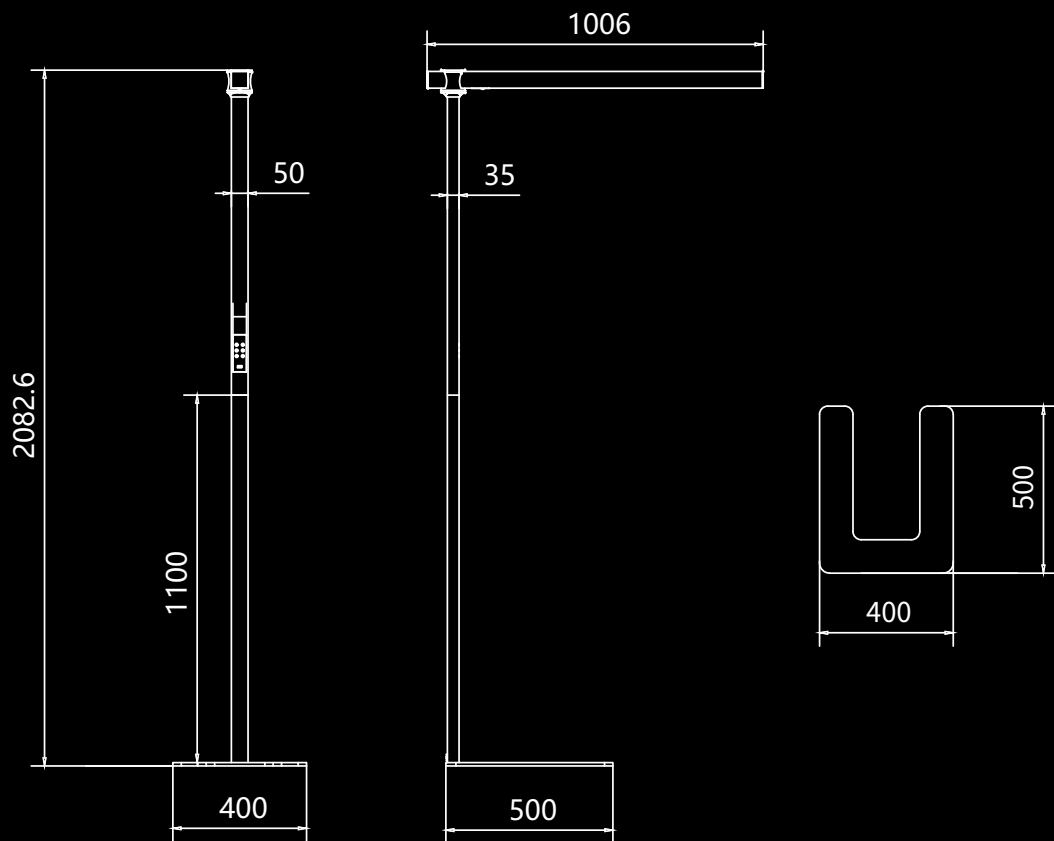

- \* Rotatable light head for more flexibility
- \* Sunlike LED equipped for better visual comfort and health
- \* Recessed reflector for low glare
- \* USB charging port, suitable for office
- \* CCT switchable, good for reading, work & relax

# ACCESSORIES

---

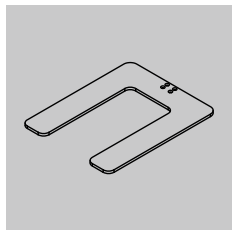

**Base**

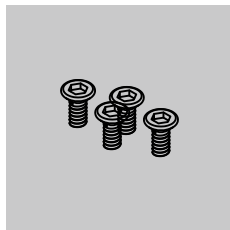

**Countersunk screws  
M4\*10---4pcs**

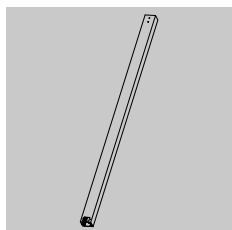

**Down pole**

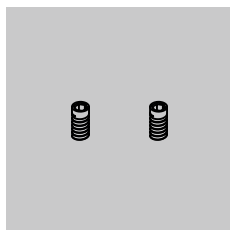

**Inner-hexagon screws  
M4\*5 ---2pcs**

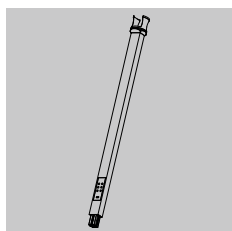

**Up pole**

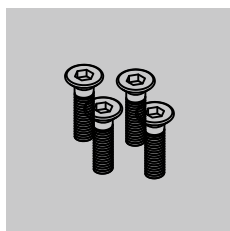

**Countersunk screws  
M6\*20---4pcs**

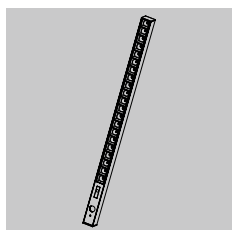

**Light module**

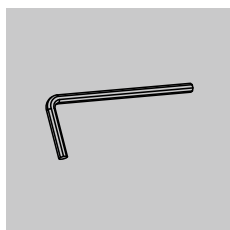

**T Hexagon wrench  
Small**

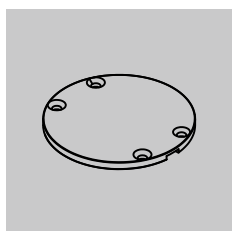

**Fixing cap**

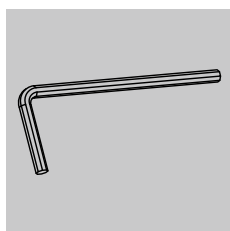

**T Hexagon wrench  
Big**

# PACKAGING

Much smaller than traditional freestanding lamp

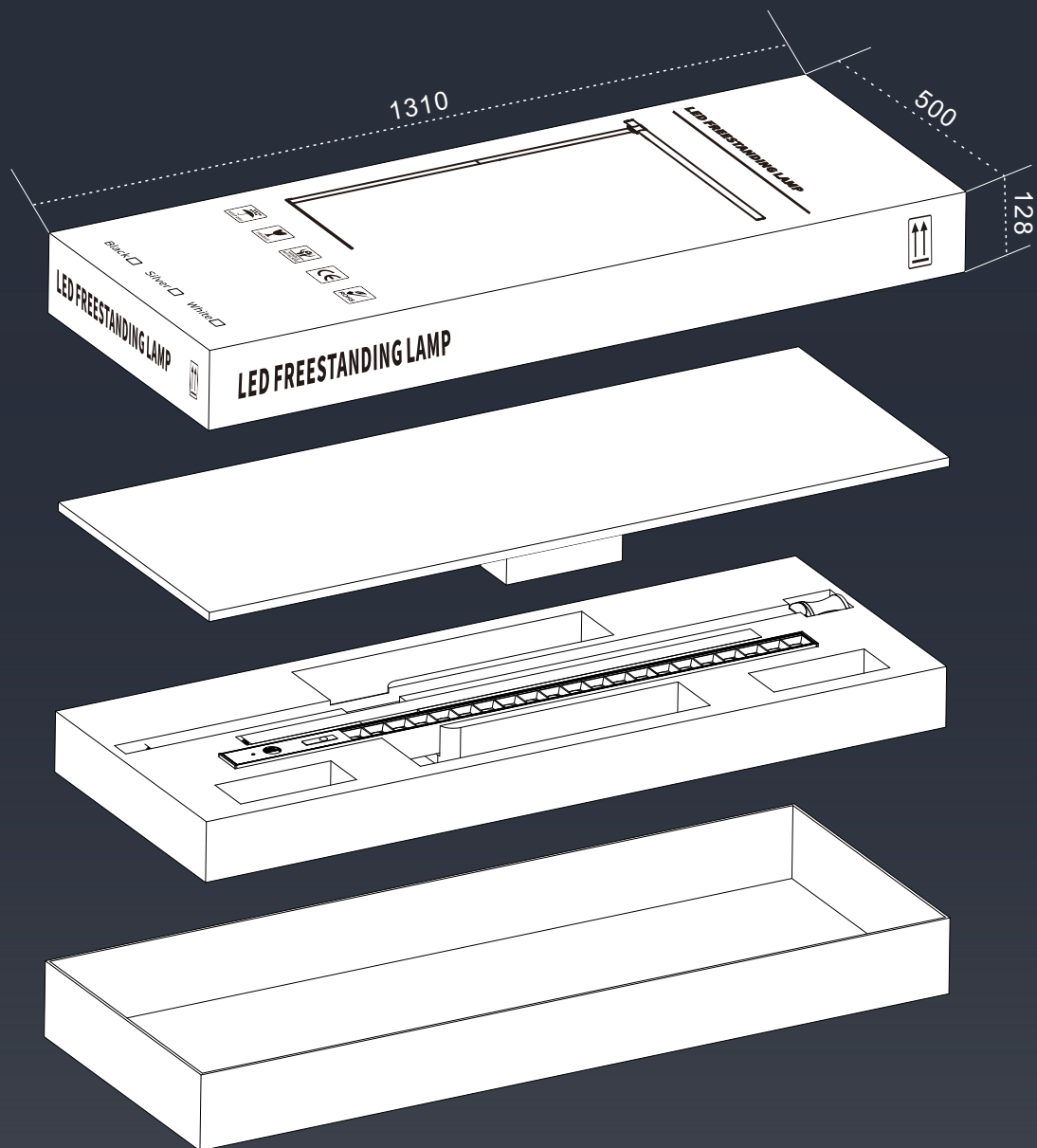

Convenient for all kinds of shipping

# APPLICATION

---





